

048-APACI-10

DELLA®

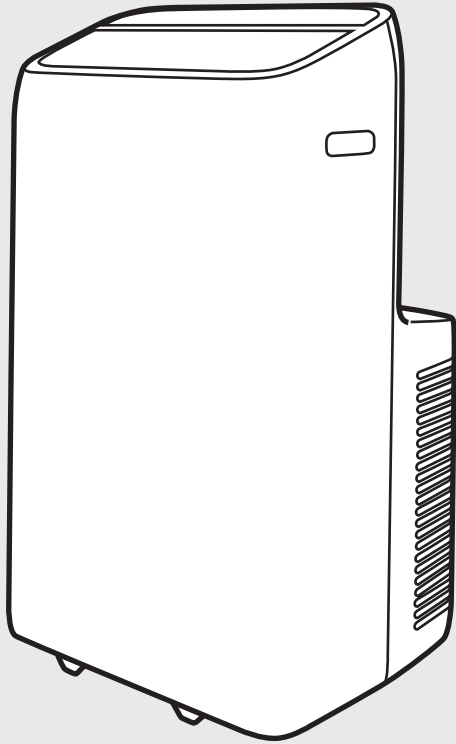

Instruction Manual

This manual contains the information you need to install and use your product. Keep the this manual for future reference.

Table of Contents

Warning and Safety -----	04
Product Specification -----	06
Parts Details -----	07
Installation Guide -----	09
Control Panel -----	12
Remote Control -----	13
Operation Instructions -----	15
WI-FI / App Connection -----	20
Care and Maintenance -----	24
Troubleshooting -----	25

Warning and Safety

*Read this guide before installation and using this appliance. Failure to follow the safety instructions may result in property damage, serious injury, or death.

DANGER

Indicates an **imminently** hazardous situation that, if not avoided, will result in death, serious injury, or serious property damage.

WARNING

Indicates a **potentially** hazardous situation that, if not avoided, will result in death, serious injury, or serious property damage.

CAUTION

Indicates a **potentially** hazardous situation that, if not avoided, will result in minor to moderate injury. It may also be used to indicate unsafe practices.

DANGER

- In the case of the appliance emitting smoke or burning smell, shut down the appliance and disconnect from the power supply immediately.
- This appliance uses R32 refrigerant. Handle the air conditioner with care and check if there is any refrigerant leakage. In the case of refrigerant leakage, shut down the appliance and disconnect from the power supply. Contact a qualified technician for inspection. Refrigerant can be toxic and flammable. Rapid evaporation of refrigerant may cause frostbite, cardiac arrhythmia, and / or skin irritation.

WARNING

- This appliance must be plugged directly into a wall power socket. Do not connect this appliance to a power strip, extension cord, surge protector, timers, or direct breaker.
- Ensure the voltage and current rating of the power supply corresponds to that on the product specification.
- Make sure the appliance is connected to a properly grounded power outlet only.
- Do not use the appliance with a damaged cord or plug, or after the heater malfunctions, has been dropped, or damaged in any manner.
- This appliance is designed to be used indoors only. Do not use this appliance outdoor or expose it to outdoors elements such as rain, snow, sunlight, wind, or extreme temperatures.
- Do not place or use the appliance in the bathroom, laundry area, or places that might come into contact with water.
- Do not use this appliance near flammable substances such as alcohol, gasoline, paint, etc. Or pressurized containers such as spray cans.
- Repairs should be carried out by a professional or qualified technician only. Incorrect repair could expose the user to potential electric shock or other kinds of hazards.
- Do not place the appliance in contact with water. The electrical insulation could be damaged and thus cause electric shock.
- Do not bend, tug, pull or compress the power cord to prevent damaging the power cord.

Warning and Safety

CAUTION

- Do not run the power cord under the carpet or cover the cord with throw rugs, runners, or similar covering. Arrange the cord away from high traffic area to prevent tripping over it.
- Only use this appliance as described in this manual.
- Do not obstruct the air inlet or outlet.
- Do not use abrasive solvents to clean this appliance.
- Proper adult supervision is required when using this appliance and there are children, persons with reduced physical, sensory, or mental capabilities, or pets present.
- Do not leave the appliance operating unattended.
- Do not touch any moving parts when the air conditioner is in operation.

Product Specification

Model	048-APACI-10
Rated Power	1200 W
Rated Voltage	115 V
Frequency	60 Hz
Rated Current	12 A
Cooling Capacity	10000 BTU / h
SEERS	7.83
Operation Temperature	60°F - 90°F

Parts Details

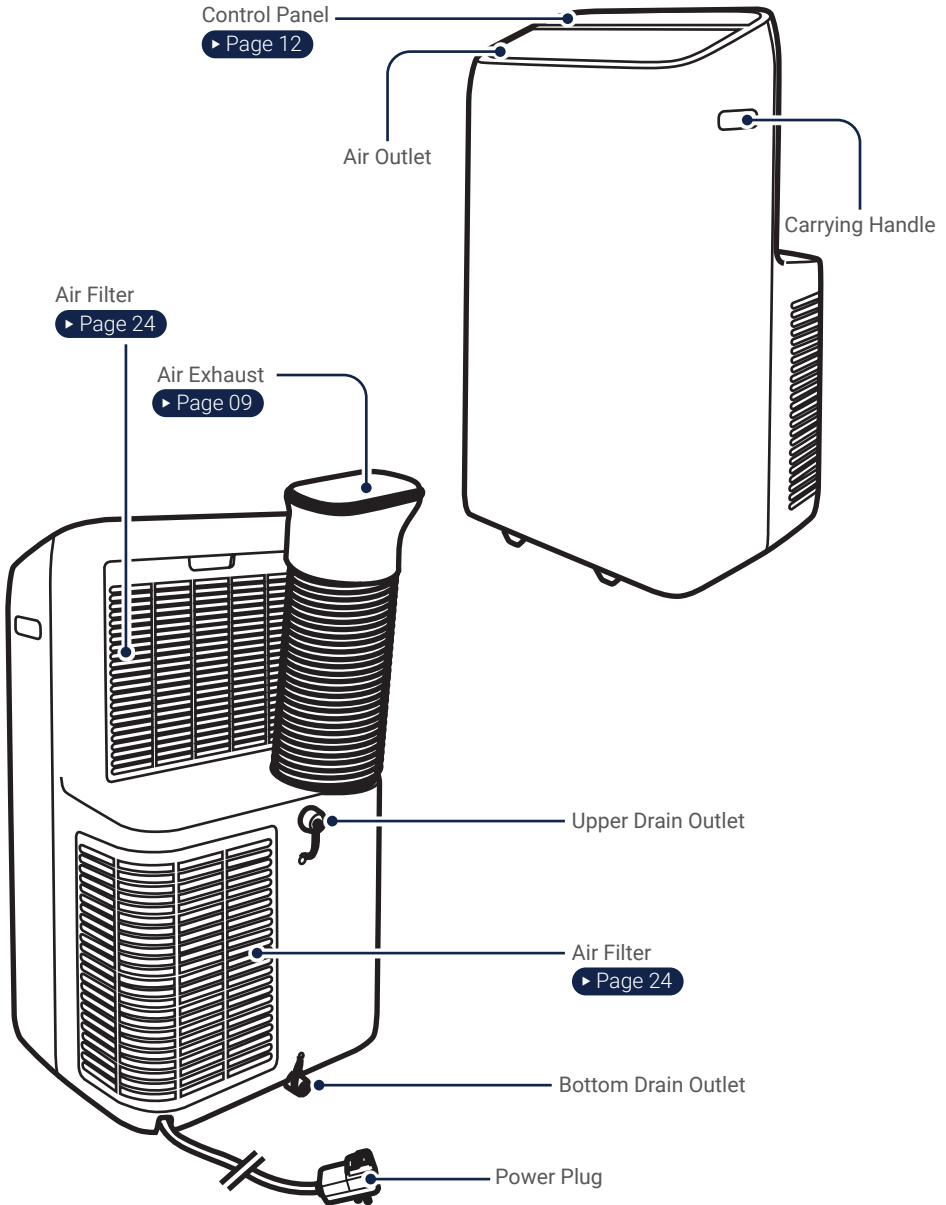

NOTE:

- The graphical representation might have slight differences than the actual product.

Parts Details

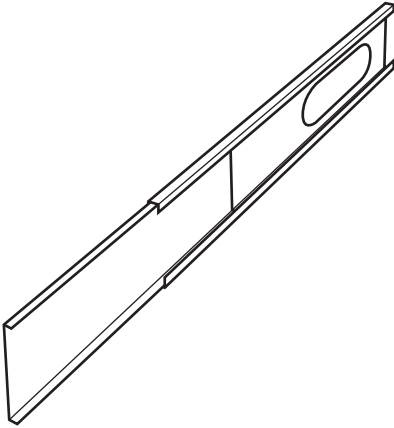

Window Slider Kit
1x

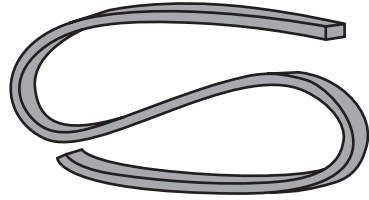

Foam Seal
1x



Drain Hose
1x

Installation Guide

Picking a installation location

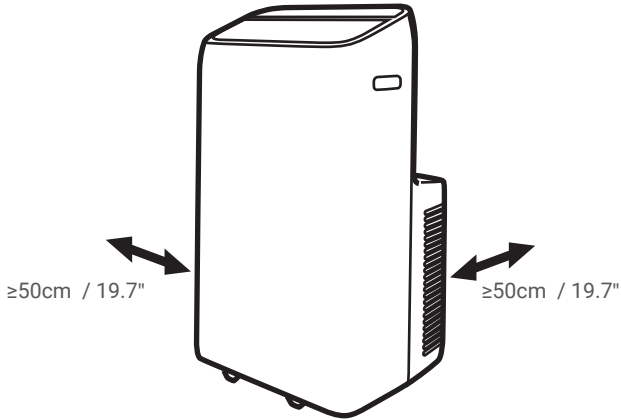

- The air conditioner must be placed on a flat ground.
- Keep the air conditioner at least 50 cm or 19.7" away from any wall or obstacles.
- Do not place the air conditioner in a laundry room or near any open ignition sources such as open flames, gas appliances, or electric heaters.

Attaching exhaust hose

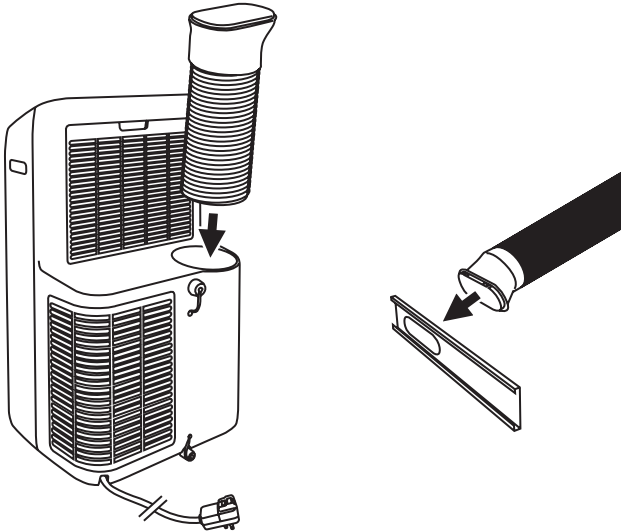

- Firmly click the exhaust duct to the exhaust opening.
- Attach the other end of the exhaust duct to the window slider kit.

Installation Guide

Picking a installation location

Horizontal Window

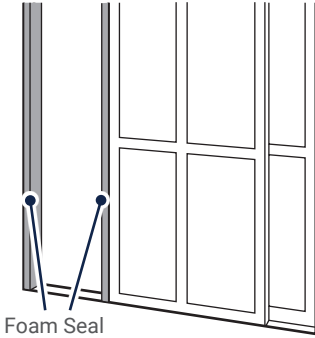

Vertical Window

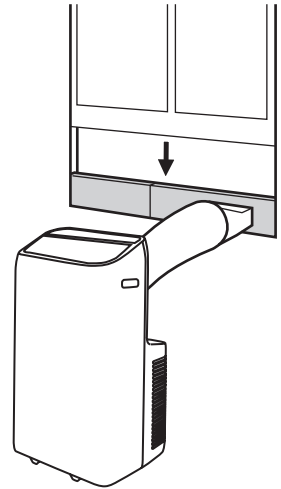
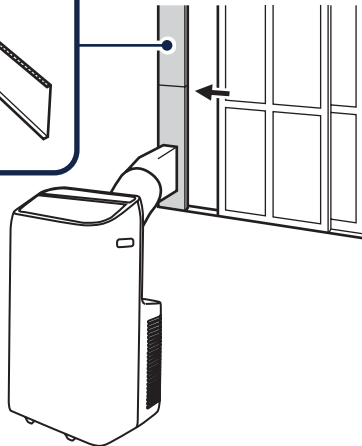
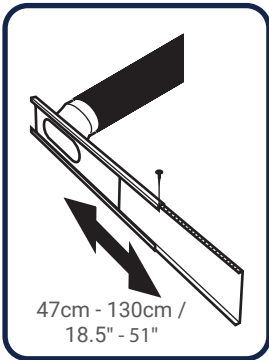
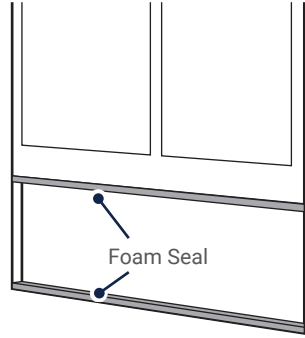

1. Attach foam seal to the window sash and the window frame.
2. Adjust the length of the window slider kit and secure the position with the provided screws.
3. Place the window slider kit between the window sash and window frame.

Installation Guide

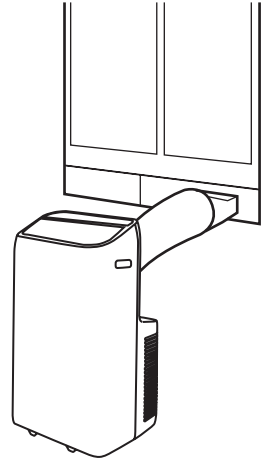
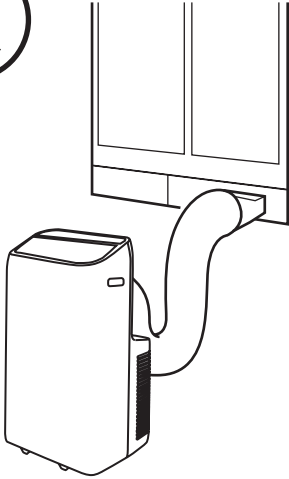

- Exhaust duct should be kept to a minimum length and as straight as possible.
- Stretching or bending the duct excessively will decrease cooling efficiency.

Control Panel

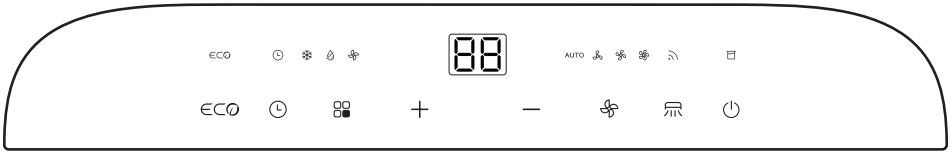

Icon	Button Name	Function
	Power Button	Power ON / OFF the air conditioner ▶ Page 15
	Oscillation Button	Enable the air outlet to oscillate ▶ Page 16
	Fan Speed Button	Control the fan speed ▶ Page 16
	Increase / Decrease Button	Adjust temperature / timer / unit setting ▶ Page 15, 17
	Mode Button	Change the operation mode setting ▶ Page 15, 16
	Timer Button	Enable shut down / turn on timer ▶ Page 17
	Eco Button	Enable ECO mode ▶ Page 16

Remote Control

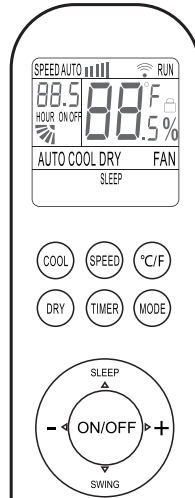

Icon	Button Name	Function
ON/OFF	Power Button	Power ON / OFF the air conditioner ▶ Page 15
SWING	Swing Button	Enable the air outlet to oscillate ▶ Page 14
SPEED	Speed Button	Control the fan speed ▶ Page 16
+ -	Increase / Decrease Button	Adjust temperature / timer / unit setting ▶ Page 15, 17
MODE	Mode Button	Change the operation mode setting ▶ Page 15, 16
COOL	Cool Button	Shortcut for cool mode ▶ Page 15
DRY	Eco Button	Shortcut for dry mode ▶ Page 15
TIMER	Timer Button	Enable shut down / turn on timer ▶ Page 17
SLEEP	Sleep Button	Enable sleep mode ▶ Page 18
°C/F	Unit Button	Changing display unit between °C and °F ▶ Page 17

Remote Control

Changing Remote Control Battery

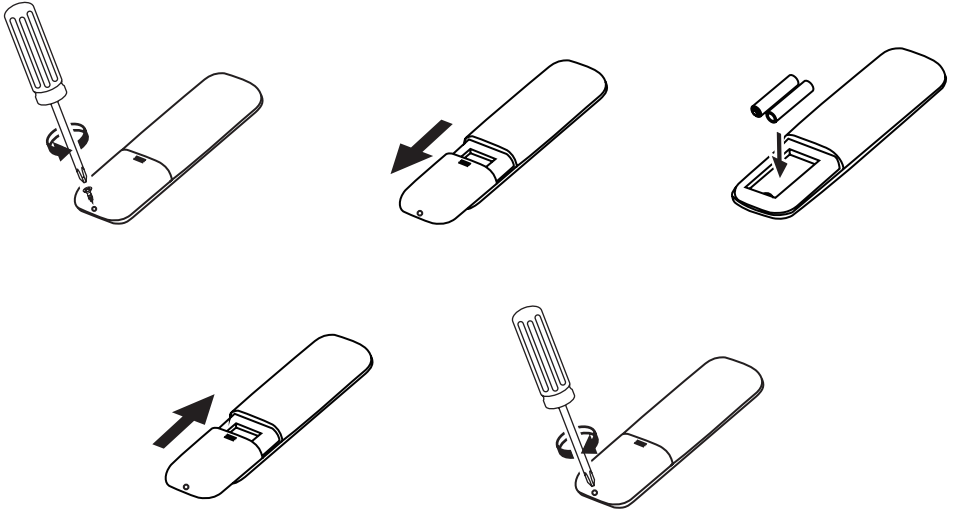



1. Remove the screw on the back cover of the remote control.
2. Remove the back cover and insert 2 new AAA 1.5v batteries.
3. Re-install the back cover to the remote control and secure with the screw.

WARNING

- Do not use rechargeable batteries.
- Replace the old batteries with new ones of the same type.
- Do not dispose batteries as unsorted municipal waste.

Operation Instructions

Power ON / OFF

1. Press  on the control panel or press **ON/OFF** on the remote control to turn on the unit.
2. Press  on the control panel or press **ON/OFF** on the remote control again to turn off the unit.

Auto Mode



1. Press **MODE** on the remote control to select auto mode.
 - **AUTO** indicator will lights up on the remote control display.

NOTE:

In the AUTO mode



- 1.The fan speed on the control panel is not available
- 2.The temperature, ECO and sleep mode is not available.

Cool Mode

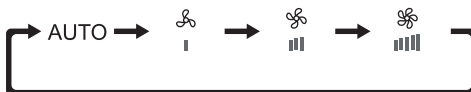
1. Press  on the control panel or **MODE** or **COOL** on the remote control to select cool mode.
 -  indicator will lights up on the control panel.
 - **COOL** indicator will lights up on the remote control display.
2. Press **+** **-** on the control panel or on the remote control to adjust temperature setting.
 - Operation temperature range from 16°C - 32°C / 60°F - 90°F.
3. Press  on the control panel or **SPEED** on the remote control to adjust fan speed.





Dry Mode

1. Press  on the control panel or **MODE** or **DRY** on the remote control to select dry mode.
 -  indicator will lights up on the control panel.
 - **DRY** indicator will lights up on the remote control display.



Operation Instructions

Fan Mode

1. Press  on the control panel or **MODE** on the remote control to select fan mode.
 -  indicator will lights up on the control panel.
 - **FAN** indicator will lights up on the remote control display.
2. Press  on the control panel or **SPEED** on the remote control to adjust fan speed.



Oscillation Function

1. Press  on the control panel or **SWING** on the remote control to select fan mode.
 - The vents on the air conditioner will osciallate side to side.
2. Press  on the control panel or **SWING** on the remote control again disable vent oscillation.

ECO Mode



1. Press **ECO** on the control panel when the air conditioner is operating in cool mode to enable ECO mode.
 - **ECO** indicator will lights up on the control panel.
 - The air conditioner will operatate with lower power consumption for 8 hours in ECO mode.

NOTE:



- ECO mode is not accessible on the remote control.

Operation Instructions

Turn ON Timer

1. Make sure the air conditioner is OFF.
2. Press  on the control panel or **TIMER** on the remote control to begin setting turn on timer.
3. Press **+** **-** on the control panel or on the remote control to set the desired time.
4. Leave the setting for 5 seconds, the air conditioner will start the timer automatically.
5. When timer function is initiated, press  on the control panel or **TIMER** on the remote once to view the remaining time, press the button twice to cancel timer.

Shut OFF Timer

1. Make sure the air conditioner is ON.
2. Press  on the control panel or **TIMER** on the remote control to begin setting shut off timer.
3. Press **+** **-** on the control panel or on the remote control to set the desired time.
4. Leave the setting for 5 seconds, the air conditioner will start the timer automatically.
5. When timer function is initiated, press  on the control panel or **TIMER** on the remote once to view the remaining time, press the button twice to cancel timer.

NOTE:

If the panel is used to start the timing, you need to press the Timer key again on the remote control to set the time on the remote control.

Changing Temperature Unit

1. Press **+** and **-** on the control panel for 3 seconds or **°C/F** on the remote control to change temperature unit between degree Celsius and degree Fahrenheit.

Operation Instructions

Sleep Mode

1. Press **SLEEP** on the remote control to enable sleep mode.

- The air conditioner will automatically adjust temperature and fan speed for sleep mode for 8 hours.

NOTE:

- Sleep mode is not accessible on the control panel.

Child Lock

1. Press **MODE** and **DRY** on the remote control for 3 seconds to enable child lock.

-  indicator will show up on the remote control.

NOTE:

- Child lock function is not accessible on the control panel.

WI-FI Function

1. Press + and **COOL** on the remote control for 3 seconds to enable WI-FI function. And it will ring eight times- Pair your air conditioner to your smart phone application  and **COOL** on the remote control for 3 seconds to enable WI-FI function.
2. Please configure the network when the remote control is on. If you configure the network when the remote control is off, the product will shut down. At this time, you need to restart.
- Pair your air conditioner to your smart phone application.

Operation Instructions

Water Drainage

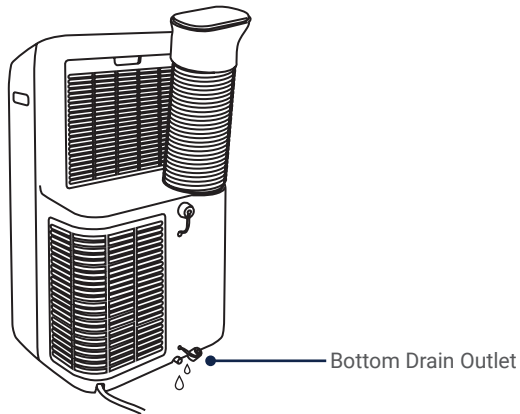

- When the internal water tank is full the digital display will show "FL" and  indicator will light up.
- Carefully move the air conditioner to a drain location, then remove the bottom drain plug and drain the water.
- After draining, re-install the drain plug and restart the air conditioner.

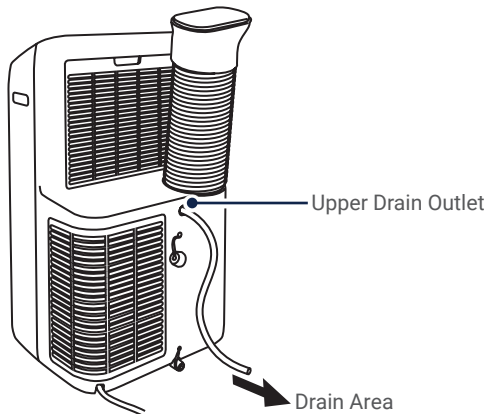

- For continuous drainage during dry mode, remove the upper drain plug and insert a drain hose to the outlet.
- Place the other end of the hose to a drain area.

Wi-fi / App Connection

Download the Application



- Search "DELLA+" on app store or google play, or scan the QR code below to download the application.
- Enable permission of storage, location, and camera for this application, otherwise it will have a problem operating.



NOTE:

- The Della+ application is free; however, data charges may apply when downloading or using the application.
- Every effort has been made to ensure the accuracy of the instruction and graphic representations at the time of producing this user guide. Your application's user interface, icons, and screen may look different from this guide due to updates and development changes.
- Della+ app can be altered without notice for quality improvement and also be deleted depending on the circumstances of manufacturing firms.

Wi-fi / App Connection

User Registration



1 Open the DELLA+ app on your smart devices.

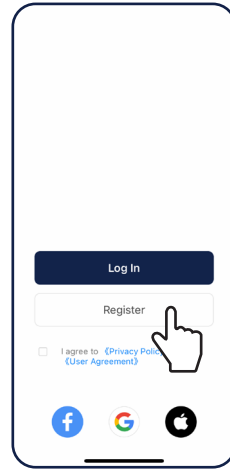

2 Tap the "Register" button for first time user.

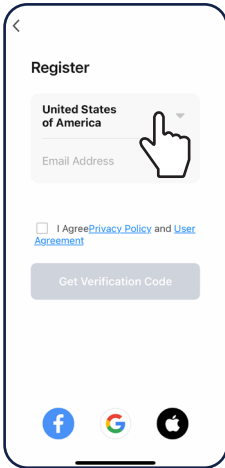

3 Tap the country menu.

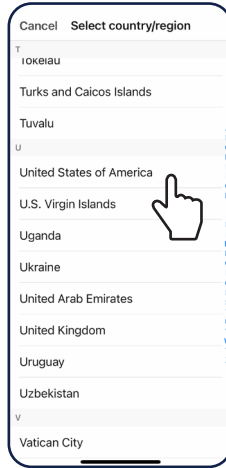

4 Select your country.

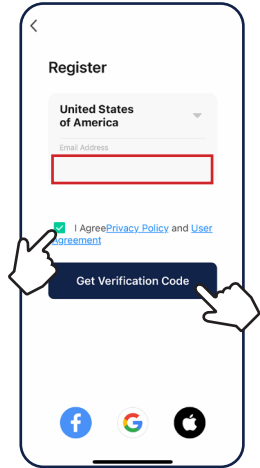

5 Enter your email address, then read and agree to the user agreement, and get verification code.

Wi-fi / App Connection

User Registration

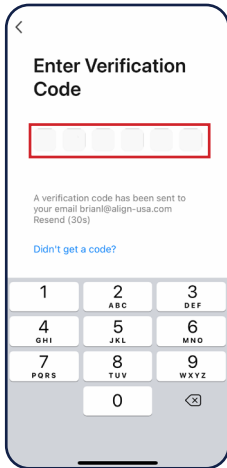

- 6 Enter the verification code.

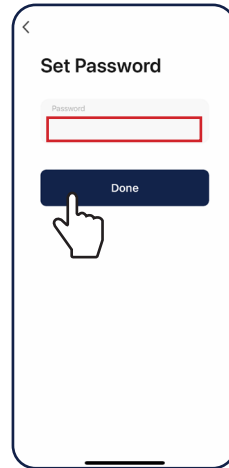

- 7 Set your password and tap "Done".

Wi-fi / App Connection

Add Device

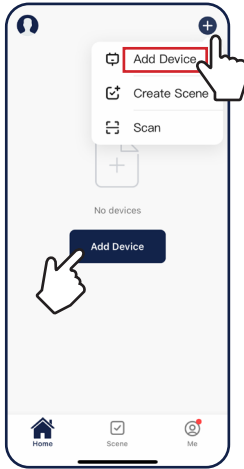

- 1 Tap "Add Device" in the center of the screen or the "+" dropdown menu from the top right corner.

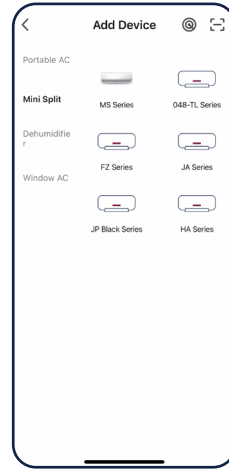

- 2 Select the appliance type you want to add.

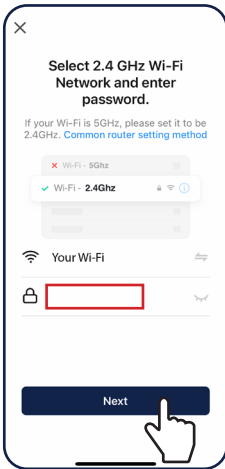

- 3 Enter your Wi-Fi network password, then tap "Next".

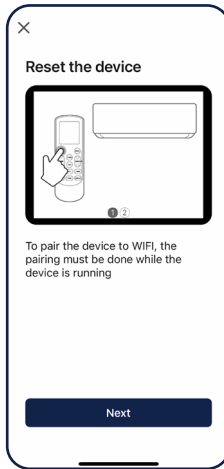

- 4 Follow the in-app instruction on adding the device.

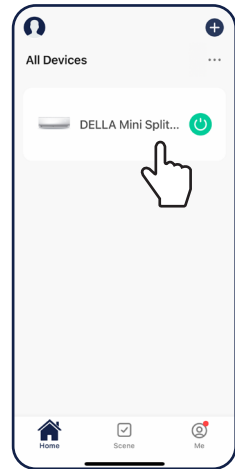

- 3 You can see your device on the device list after adding.

Care and Maintenance

⚠ CAUTION

- Before cleaning the unit, you must shut down the machine and cut off the power supply.
- Never flush the air conditioner with water.

Clean the Unit

1. Clean the heater with a soft dry cloth or a dampened cloth with neutral detergent.

NOTE:

- Do not flush the machine with water.
- Do not use volatile liquids such as thinner or alcohol to prevent damaging the unit.

Clean the Air Filter

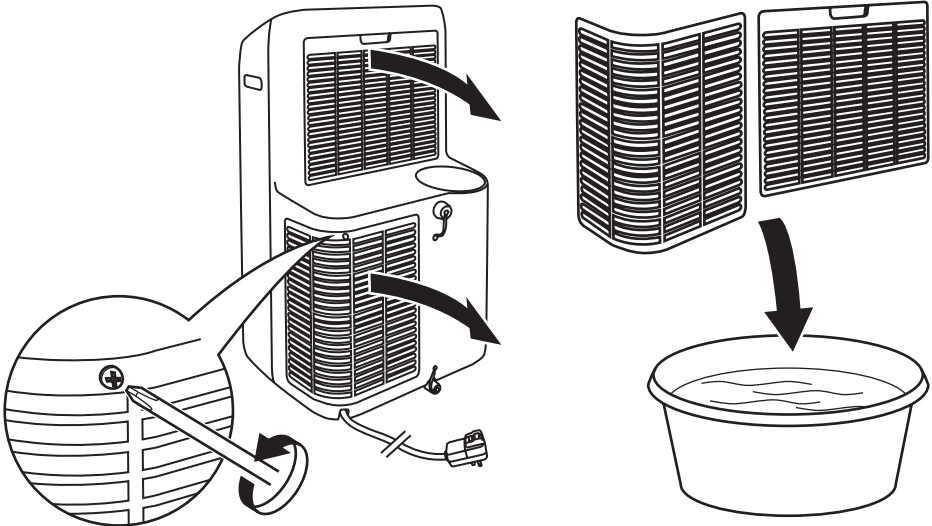

1. Remove the air filters from the air conditioner.
2. Clean the air filters with vacuum cleaner or with warm water with mild neutral detergent.
3. Make sure air filters are dry and then re-install it to the air conditioner.

Troubleshooting

Problem	Possible Causes
The appliance is nonoperational	Power failure / plug pulled out
	Power breaker tripped
The appliance does not start when power on	4 minutes reset after shutting down the appliance
	Temperature setting is higher than the environment temperature
Poor Cooling effect	Obstruction on the vent
	Dirty air filter
	Room is too big
	doors and / or windows are open
	Room is too hot
Noise or Vibration	The appliance is placed on uneven ground



www.dellahome.com

manufacturer@dellahome.com

800-863-4143

6:00a.m. – 4:00p.m. PST Monday - Friday

©Della All rights reserved.

Under the copyright law, this document may not be printed, translated, reproduced, or distributed, in whole or in part without written permission from DELLA.

Every effort has been made to ensure that the information in this document is accurate, DELLA is not responsible for printing or clerical errors.

All trademarks, logos, and brand names are the property of their respective companies. Mention of third-party products or service names is for identification and informational purposes only. Use of these names, brands, and trademarks does not imply endorsement. DELLA assumes no responsibility with regard to the performance or use of these products.