

# DELLA®



## Umbra (JPB) Series



Instruction Manual  
Installation and Operation Guide



Watch video  
before Installation



# Welcome to DELLA®

## 5 Things to know before installation

Thank You for trusting Della as your home comfort solution. We know no better how exciting it must be to have a new and functional AC to make your living space more comfortable. But AC installation, in reality, is far from being simple. Here are a few things you must know before installing the AC whether by yourself or by a professional HVAC technician. This will give you an idea of what to look out for installing an AC so that it can perform at its maximum efficiency and every dollar you invest in it pays off.



### The installation location is critical

Not all places are created equal. Only proper placement of the AC will maximize efficiency while balancing the interior aesthetic. As wall requires for the installation, you need to make sure to get the placement and location right the first time.

Page 12



### Handle the refrigerant pipes perfectly

The refrigerant pipe is one of the most important, if not the most important, parts of the mini split AC system. So, be sure to understand what the entire process entails. You might need special-purpose tools to shorten and bend the pipe. Purchasing lengthening pipes to match your connection might also be necessary. Any flow in the handling of the refrigerant pipes may cause a refrigerant leak or reduced efficiency. The cost to repair or re-install the refrigerant pipe can quickly frustrate and upset any DIYer, especially when trying to save money by not hiring a professional. Additional refrigerant might also be needed if you used lengthening pipes or find any leaks during your install. Further more, it's always a good idea to test for any refrigerant leaks after completing your installation by using soapy spray or professional detector tools. Please contact us if you need extra refrigerant.

Page 20



### Bundle the line set correctly

The line set contains the refrigerant pipes, drain hose, and electrical wires. A good bundling prevent water condensation and protects it from external elements, as well as matching the exact distance of the installation. No one wants extra line set dangling around.

Page 16, 32



### Vacuum pumping the refrigerant circuit

Mini-split AC absolutely needs vacuum pumping in order to perform efficiently and prevent refrigerant from reacting with air moisture and damaging the internal parts of the machine. With a vacuum pump and a micron gauge, the process does not take very long, but it is important to do it right.

Page 28



### Safe electrical connection

A safe and properly electrical connection is crucial necessity for the installation. The voltage, power breaker protection, cable requirement and wiring must correspond to the specifications of each model. A poor connection can quickly becomes a fire hazard.

Page 11, 23



Most of the problems emerge from incorrect or poor installation. Installation performed by professional HVAC technician can greatly reduce the chance of having problems for years to come. On top of that, Della provide extended warranty for professional installation. If you need assistance or have questions, we are here for you.



support.dellahome.com



800-863-4143  
6:00 a.m. - 4:00 p.m. PST  
Monday - Friday



24/7 Live Chat

## Table of Content

### Before Installation

Warning and Safety	04
Name of Parts	07
Product Specification	09

### Installation

Installation Preview	11
Installation Info	14
Indoor Unit Installation	15
Outdoor Unit Installation	20
Circuit Diagram	27
Finishing Touch	34
Check List	35
Test Run	36

### Before Using

Operation Tips	37
Front Panel	38
Remote Control	39

### Basic Operation

Power ON / OFF	44
Operation Modes	44
- Auto, Cool, Heat, Dry, Fan	44
Change Temperature	45
Change Fan Speed	45
Adjust Airflow	46

### Advance Function

Turbo Mode	47
Quiet Mode	47
Eco Mode	48
Sleep Mode	48
Timer	49
Vicinity Sensor	50
Display ON / OFF	50
Self Cleaning	51
Child Lock	51
°F / °C	52
Force Defrost	52
Wi-Fi Reset Button	53
Filter Cleaning Reset	53
Emergency Button	56
Wi-Fi Setup	57

### Care and Maintenance

Air Filter	58
Maintenance Routine	59

### Having Problems?

Troubleshooting	60
Disposal Guideline	63
Warranty	64

## Warning and Safety

- Read this guide before installation. Failure to follow the safety instructions may result in property damage, serious injury, or death.
- Please Keep this manual.



**Danger:**  
Indicates an IMMEDIATELY hazardous situation that, if not avoided, will result in death, serious injury, or serious property damage.



**Warning:**  
Indicates an POTENTIALLY hazardous situation that, if not avoided, will result in death, serious injury, or serious property damage.



**Caution:**  
Indicates an POTENTIALLY hazardous situation that, if not avoided, will result in minor to moderate injury. It may also be used to indicate unsafe practice.



**Attention:**  
Pay additional attention to the instruction.



**DO NOT:**  
Indicates prohibited actions and / or practice.

## About Refrigerant



- The air conditioner is pre-charged with refrigerant. Handle the air conditioner with care and check if there is any refrigerant leakage during installation. Refrigerants have no odor and can be toxic and flammable. Rapid evaporation of refrigerant may cause frostbite, cardiac arrhythmia, and / or irritation, as well as cause environmental damage.



- In the case of refrigerant leakage, shut down the appliance and disconnect from the power supply. An inspection must be performed by a qualified technician.



- R32 refrigerant should be treated with care. Charge amount of refrigerant should strictly followed according to the manufacture spec, local codes and safety requirements. Read the table below for room space to refrigerant charge ratio requirement.





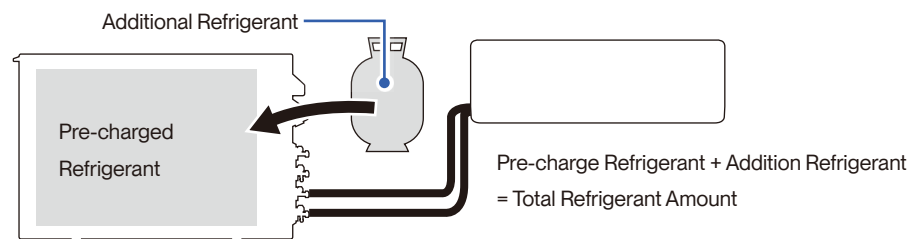

	Charge Amount	Minimum Floor Area for Installation
R32 Refrigerant	< 64.9 oz / < 1.84 kg	75.35 sq ft / 7m <sup>2</sup>
	64.9 - 52.54 oz / 1.84 - 2.34 kg	96.88 sq ft / 9m <sup>2</sup>
	82.58 - 100.18 oz / 2.341 - 2.84 kg	113.02 sq ft / 10.5m <sup>2</sup>
	100.21 - 117.82 oz / 2.841 - 3.34 kg	134.55 sq ft / 12.5m <sup>2</sup>
	117.85 - 135.45 oz / 3.341 - 3.84 kg	150.69 sq ft / 14m <sup>2</sup>
	135.49 - 153.09 oz / 3.841 - 4.34 kg	193.75 sq ft / 18m <sup>2</sup>

- The total refrigerant charge should be calculated by adding the precharge amount and additional amount.







# Warning and Safety



## About Refrigerant

 	<ul style="list-style-type: none"> <li>When Installing or using the appliance with R32 refrigerant, beware of the following symbols. <ul style="list-style-type: none"> <li> A2L This symbol means this appliance uses a flammable refrigerant. If the refrigerant is leaked and exposed to an external ignition source, there is a risk of fire.</li> <li> This symbol means that read the operation instruction carefully.</li> <li> This symbol means that personnel handling the equipment should reference to the installation manual.</li> <li> This symbol means information is available in the installation or operation instruction manual.</li> </ul> </li> </ul>
--	--

## About Installation



 	<ul style="list-style-type: none"> <li>The room for the installation, use, repair, and / or storage of this air conditioner should be greater than 54 sq ft / 5m<sup>2</sup>.</li> <li>Stop valve cover must be installed on the air conditioner to prevent possible refrigerant leak.</li> <li>Refrigerant leakage or damaged pipelines must be inspected and repaired by a qualified HVAC technician.</li> <li>The appliance must be installed in accordance with applicable federal, state, and local regulations.</li> <li>When evacuating mini-split system with A2L rated refrigerant, an A2L rated vacuum pump must be used. If an A2L rated pump is not available, vacuuming must be done outdoor only. Failure to follow this instruction may result in fire or explosion hazard.</li> </ul>
 	<ul style="list-style-type: none"> <li>Do not install or store this appliance in a room with continuously operating ignition sources such as open flames, gas appliances, or electric heater.</li> <li>Do not install the appliance within 20" / 50cm of flammable substances such as alcohol, etc. Or pressurized containers such as spray cans.</li> <li>Do not alter, change, or modify the appliance.</li> </ul>
	<ul style="list-style-type: none"> <li>Before installation, make sure the AC system is placed on a flat and stable platform in its upright position for at least 6 hours to prevent lubricating oil from damaging the compressor.</li> <li>Prevent children from accessing the work area during installation to prevent unforeseeable accident.</li> <li>The base of the outdoor unit must be firmly fixed.</li> <li>Carry out a test run after the installation.</li> <li>Installation of a mini split AC requires specialized training and equipment. Hire a licensed professional if not familiar with electrical wiring and HVAC system.</li> <li>The packaging materials are recyclable and should be disposed of in a separate waste bins.</li> <li>The appliance should not be installed in a location where the air outlet of the indoor or outdoor unit is obstructed. Obstruction of these opening may cause damage or malfunctions to the appliance.</li> </ul>



## About Power and Electricity



 	<ul style="list-style-type: none"> <li>Ensure that the power voltage corresponds to that stamped on the rating plate.</li> <li>A fuse or overload protection device with a suitable capacity for indoor unit must be installed.</li> <li>The appliance must be fitted with means for disconnection from the main power supply under over-voltage category III conditions. All electrical wiring must follow federal, state, or local regulations.</li> <li>When working on the electric terminals, ensure the appliance is disconnected from the power supply.</li> <li>Make sure the appliance is properly grounded to prevent electric shock.</li> </ul>
--	--



## Warning and Safety

Before Installation  
Before Installation

About Power and Electricity	
 WARNING  	<ul style="list-style-type: none"> <li>Do not bend, tug, or compress the power cord during installation to prevent damaging the power cord. Damaged electrical cord should be replaced by a qualified electrician.</li> <li>Do not use power extensions and / or multi-socket modules for appliance installation.</li> </ul>

About Operation	
 WARNING  	<ul style="list-style-type: none"> <li>Do not disconnect the appliance from the power supply before shutting off the appliance. This might create a spark and potentially cause a fire.</li> <li>Do not place flammable substances near the appliance.</li> <li>Do not climb onto or place any objects on the appliance.</li> <li>Do not insert any objects into the appliance to prevent damage or injury.</li> <li>Do not obstruct the air inlet or outlet.</li> <li>Do not operate the appliance with wet hands.</li> </ul>
 CAUTION	<ul style="list-style-type: none"> <li>If the appliance is used in areas without the possibility of ventilation, precautions must be taken to prevent any leaks of refrigerant.</li> <li>Only use the appliance as instructed in this booklet. These instructions are not intended to cover every possible condition and situation. As with any electrical household appliance, common sense and caution are therefore always recommended for usage and maintenance.</li> <li>This appliance is designed and made for air conditioning in domestic environments only. It must not be used for any other purpose such as drying clothes or cooling foods.</li> <li>This appliance can be used by children 8 years old or above and persons with reduced physical, sensory, or mental capabilities, or lack of experience and knowledge if they have been given supervision or instruction concerning the use of the appliance in a safe way and understand the hazards involved.</li> <li>Children shall not play with the appliance.</li> </ul>

Encountering Troubles	
 WARNING  	<ul style="list-style-type: none"> <li>In the case of the appliance emitting smoke, burning smell, leaking water, or making unusual noise, shut down the appliance and disconnect from the power supply immediately. Contact a qualified technician for inspection and repair.</li> </ul>

About Handling and Maintenance	
 WARNING  	<ul style="list-style-type: none"> <li>Do not attempt to disassemble, alter, or modify the appliance.</li> <li>Do not flush the air conditioner with water.</li> <li>Do not attempt to repair, relocate, modify or reinstall the air conditioner by yourself. Incorrect work could cause electric shocks, fire or damage. Contact a qualified technician.</li> </ul>
 WARNING	<ul style="list-style-type: none"> <li>Before cleaning the unit, the appliance must be shut down and disconnect from the power supply for at least 5 minutes.</li> </ul>

# Name of Parts

## Indoor Unit

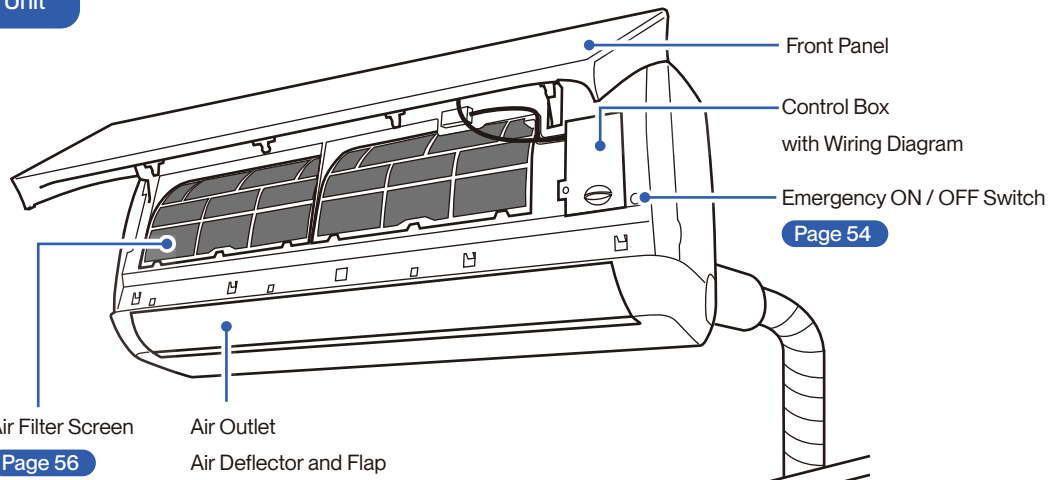

## Outdoor Unit

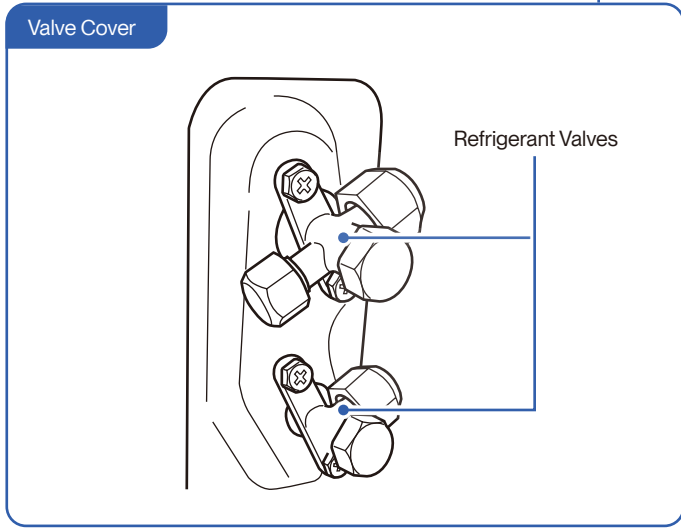
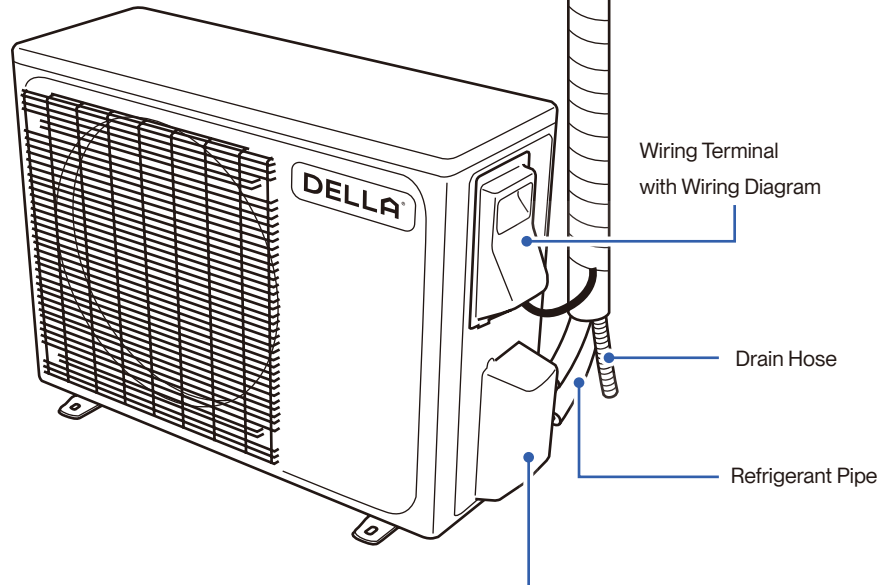

Before Installation  
Before Installation

## Name of Parts

### Included Accessories

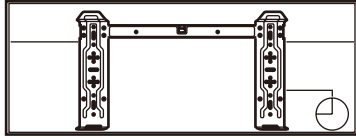

Bracket Template  
1x

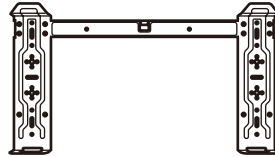

Mounting Plate  
1x



Communication Cable  
1x



Insulation Wrap  
1x

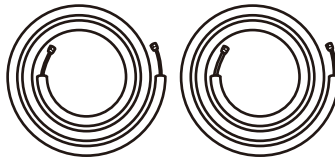

Refrigerant Pipe  
Narrow 1x  
Thick 1x



Drain Hose  
1x



Wall Cover  
1x

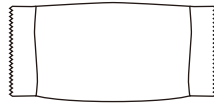

Plasticine Putty  
1x

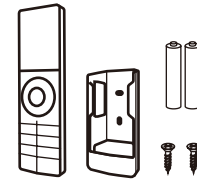

Remote Control & Holder 1x  
Battery 2x



Rubber Foot Pad  
4x

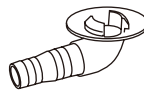

Drainage Joint  
1x

### Tools Needed (Not included)

- Screw Driver
- Hole Saw Ø2.75" / Ø70mm
- Refrigerant Leak Detector / Liquid Leak Detector
- Allen Wrench
- Spanner
- Torque Wrench
- Measuring Tape
- Spirit Level
- Stud Finder
- Thermometer
- Vacuum Pump
- Dry Wall Anchors / Molly Bolts
- Wood Screws
- Floor Mounting Base Kit / Wall Mount Kit
- Micron Gauge / AC manifold Gauge
- Copper Pipe Bender / Spring Bender
- Caulk
- Ø25mm Drainage Joint
- Ø2.5" / Ø65mm Wall Sleeve
- Tubing Cutter\*
- Pipe Reamer\*
- Tubing Flaring Tool\*
- Wire cutter\*

NOTE: Tools marked with \* are needed for shortening the refrigerant pipe and / or electrical wire to the exact desired length.

ONLY a qualified HVAC technician should attempt altering the pipe length and / or the wire length.

## Product Specification

	048-MS-9K1VRH-20S-JPB	048-MS-9K2VRH-19S-JPB	048-MS-12K1VRH-20S-JPB	048-MS-12K2VRH-19S-JPB
Power Supply	115 V / 60 Hz / 1P	208 V - 230 V / 60 Hz / 1P	115 V / 60 Hz / 1P	208 V - 230 V / 60 Hz / 1P
Rated Cooling Capacity (Btu / h)	9100	9100	12000	12000
Rated Heating Capacity (Btu / h)	10000	9200	12300	12300
Cooling	Power Consumption	920 W	1040 W	1270 W
	Rated Current	7.3 A	9.1 A	5.7 A
Heating	Power Consumption	850 W	1080 W	1070 W
	Rated Current	7.5 A	9.6 A	4.7 A
Noise Level	Indoor Unit	27-42 dBA	27-42 dBA	27-42 dBA
	Outdoor Unit	52 dBA	52 dBA	52 dBA
Dimension	Indoor Unit	31.18" x 11.5" x 7.91" 792 mm x 292 mm x 201 mm	31.18" x 11.5" x 7.91" 792 mm x 292 mm x 201 mm	31.18" x 11.5" x 7.91" 792 mm x 292 mm x 201 mm
	Outdoor Unit	27.76" x 10.98" x 20.87" 705 mm x 279 mm x 530 mm	27.76" x 10.98" x 20.87" 705 mm x 279 mm x 530 mm	27.76" x 10.98" x 20.87" 705 mm x 279 mm x 530 mm
Net Weight	Indoor Unit	17.6 lb / 8 kg	17.6 lb / 8 kg	17.6 lb / 8 kg
	Outdoor Unit	51.8 lb / 23.5 kg	49.6 lb / 22.5 kg	49.6 lb / 22.5 kg
Suitable Area	Up to 400 sq. ft	Up to 400 sq. ft	Up to 550 sq. ft	Up to 550 sq. ft
Moisture Removal (per hour)	2.1 pints / 1 L	1.9 pints / 0.9 L	2.1 pints / 1 L	2.5 pints / 1.2 L
Refrigerant	R32	R32	R32	R32

		048-MS-18K2VRH-19S-JPB	048-MS-24K2VRH-19S-JPB
Power Supply		208 V - 230 V / 60 Hz / 1P	208 V - 230 V / 60 Hz / 1P
Rated Cooling Capacity (Btu / h)		18000	23000
Rated Heating Capacity (Btu / h)		18700	24000
Cooling	Power Consumption	1650 W	2100 W
	Rated Current	7.3 A	9.5 A
Heating	Power Consumption	1650 W	2200 W
	Rated Current	7.3 A	10 A
Noise Level	Indoor Unit	29-47 dBA	30-50 dBA
	Outdoor Unit	54 dBA	57 dBA
Dimension	Indoor Unit	37" x 12.44" x 8.82" 940 mm x 316 mm x 224 mm	44.57" x 12.99" x 9.13" 1132 mm x 330 mm x 232 mm
	Outdoor Unit	30.9" x 11.8" x 21.85" 785 mm x 300 mm x 555 mm	32.4" x 11.89" x 25.79" 823 mm x 302 mm x 655 mm
Net Weight	Indoor Unit	25.4 lb / 11.5 kg	30.9 lb / 14 kg
	Outdoor Unit	59 lb / 29.5 kg	70.6 lb / 32 kg
Suitable Area		Up to 1000 sq. ft	Up to 1500 sq. ft
Moisture Removal		3.4 pints / 1.6 L	5.0 pints / 2.36 L
Refrigerant		R32	R32

## Installation Preview

- 1 Choose the installation location  
Page 12
- 2 Drill wall hole and  
Install mounting plate  
Page 13-14
- 3 Indoor unit connection
  - Connect the drain hose to the indoor unit  
Page 15
  - Pass the electrical wire into the indoor unit  
Page 16
- 4 Mount the indoor unit  
Page 17

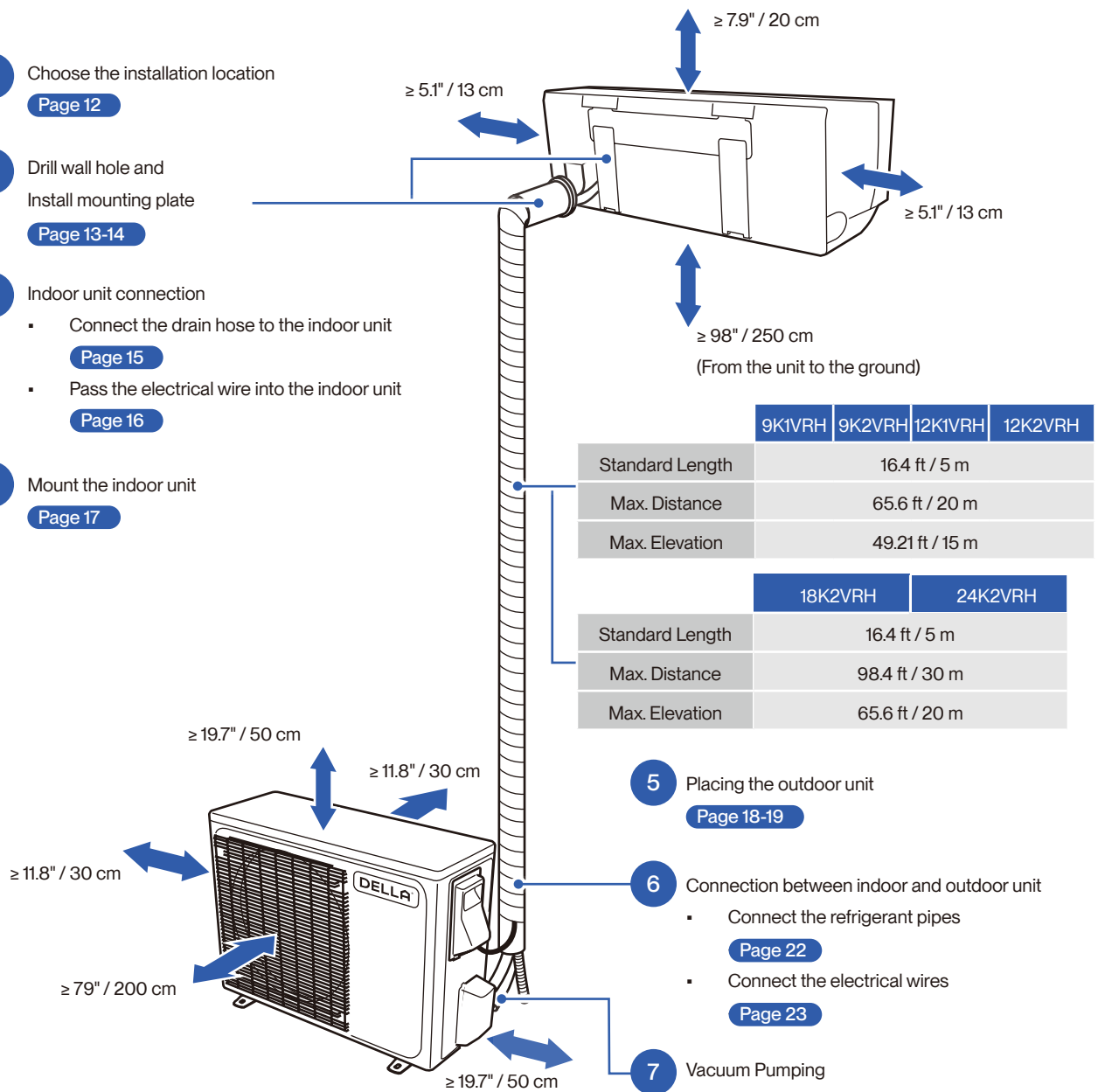

- 5 Placing the outdoor unit  
Page 18-19
- 6 Connection between indoor and outdoor unit
  - Connect the refrigerant pipes  
Page 22
  - Connect the electrical wires  
Page 23
- 7 Vacuum Pumping  
Page 28-31
- 8 Finishing  
Page 32
- 9 Check List  
Page 33
- 10 Test Run  
Page 34

Installation  
Installation

## Installation Info (Power Supply, Breaker Size, Refrigerant and Pipe Set)

Installation  
Installation

### Power Supply and Breaker Size

	048-MS-9K1VRH-20S-JPB	048-MS-9K2VRH-19S-JPB	048-MS-12K1VRH-20S-JPB	048-MS-12K2VRH-19S-JPB
Power Supply	115 V / 60 Hz / 1P	208 V - 230 V / 60 Hz / 1P	115 V / 60 Hz / 1P	208 V - 230 V / 60 Hz / 1P
Power Consumption	830 W	920 W	1040 W	1270 W
Rated Current	7.3 A	4.2 A	9.1 A	5.7 A
Power Consumption	850 W	770 W	1080 W	1070 W
Rated Current	7.5 A	3.5 A	9.6 A	4.7 A
Min. Circuit Ampacity	14 A	7.5 A	14 A	7.5 A
Min. Wire Size (American Wire Gauge)	14 AWG	14 AWG	14 AWG	14 AWG
Breaker Size	20 A	10 A	20 A	10 A

	048-MS-18K2VRH-19S-JPB	048-MS-24K2VRH-19S-JPB
Power Supply	208 V - 230 V / 60 Hz / 1P	208 V - 230 V / 60 Hz / 1P
Power Consumption	1650 W	2100 W
Rated Current	7.3 A	9.5 A
Power Consumption	1650 W	2200 W
Rated Current	7.3 A	10 A
Min. Circuit Ampacity	9.3 A	12.5 A
Min. Wire Size (American Wire Gauge)	14 AWG	14 AWG
Breaker Size	15 A	20 A

## Refrigerant and Pipe Set Info

	048-MS-9K1VRH-20S-JPB	048-MS-9K2VRH-19S-JPB	048-MS-12K1VRH-20S-JPB	048-MS-12K2VRH-19S-JPB
Standard Pipe Length	16.4 ft / 5 m	16.4 ft / 5 m	16.4 ft / 5 m	16.4 ft / 5 m
Max. Distance Between Indoor and Outdoor Unit	65.6 ft / 20 m	65.6 ft / 20 m	65.6 ft / 20 m	65.6 ft / 20 m
Max. Elevation Between Indoor and Outdoor Unit	49.2ft / 15 m	49.2ft / 15 m	49.2ft / 15 m	49.2ft / 15 m
Type of Refrigerant	R32	R32	R32	R32
Factory Refrigerant Pre-charge for up to 25ft pipe	17.6 oz / 500 g	18.6 oz / 530 g	17.6 oz / 500 g	19.8 oz / 560 g
Additional Refrigerant Charge after 25ft pipe	0.172 oz / ft (16 g / m)	0.172 oz / ft (16 g / m)	0.172 oz / ft (16 g / m)	0.172 oz / ft (16 g / m)
Liquid Line	Pipe Diameter	1/4"	1/4"	1/4"
	Torque Parameter	15 - 25 N-M / 11.1 - 18.4 lbf-ft / 1.5 - 2.5 kgf-m	15 - 25 N-M / 11.1 - 18.4 lbf-ft / 1.5 - 2.5 kgf-m	15 - 25 N-M / 11.1 - 18.4 lbf-ft / 1.5 - 2.5 kgf-m
Gas Line	Pipe Diameter	3/8"	3/8"	3/8"
	Torque Parameter	35 - 40 N-M / 25.8 - 29.5 lbf-ft / 3.6 - 4.1 kgf-m	35 - 40 N-M / 25.8 - 29.5 lbf-ft / 3.6 - 4.1 kgf-m	35 - 40 N-M / 25.8 - 29.5 lbf-ft / 3.6 - 4.1 kgf-m
048-MS-18K2VRH-19S-JPB				
Standard Pipe Length	16.4 ft / 5 m	16.4 ft / 5 m	16.4 ft / 5 m	16.4 ft / 5 m
Max. Distance Between Indoor and Outdoor Unit	98.4 ft / 30 m	98.4 ft / 30 m	98.4 ft / 30 m	98.4 ft / 30 m
Max. Elevation Between Indoor and Outdoor Unit	65.6 ft / 20 m	65.6 ft / 20 m	65.6 ft / 20 m	65.6 ft / 20 m
Type of Refrigerant	R32	R32	R32	R32
Factory Refrigerant Pre-charge for up to 25ft pipe	35.3 oz / 1000 g	45.9 oz / 1300 g	35.3 oz / 1000 g	45.9 oz / 1300 g
Additional Refrigerant Charge after 25ft pipe	0.258 oz / ft (24 g / m)	0.258 oz / ft (24 g / m)	0.258 oz / ft (24 g / m)	0.258 oz / ft (24 g / m)
Liquid Line	Pipe Diameter	1/4"	1/4"	1/4"
	Torque Parameter	15 - 25 N-M / 11.1 - 18.4 lbf-ft / 1.5 - 2.5 kgf-m	15 - 25 N-M / 11.1 - 18.4 lbf-ft / 1.5 - 2.5 kgf-m	15 - 25 N-M / 11.1 - 18.4 lbf-ft / 1.5 - 2.5 kgf-m
Gas Line	Pipe Diameter	1/2"	5/8"	5/8"
	Torque Parameter	45 - 60 N-M / 33.2 - 44.3 lbf-ft / 4.6 - 6.1 kgf-m	60-65 N-M / 44.3 - 48.0 lbf-ft / 6.1 - 6.6 kgf-m	60-65 N-M / 44.3 - 48.0 lbf-ft / 6.1 - 6.6 kgf-m

## Installation Info

### Picking a Installation Location for the Indoor Unit

- Ensure the installation complies with the minimum clearance space surrounding the unit and is within the maximum piping length and maximum elevation defined in the installation information.

Page 11

- Make sure the wall is strong enough to hold the weight of the indoor unit and prevent it from vibration.
- Make sure the air inlet and outlet are clear of any obstruction.
- Make sure condensation can be easily drained.
- A place where all connections can be easily made to the outdoor unit.
- A place where the indoor unit is out of children's reach.
- A place where the indoor unit is accessible for maintenance.
- Install the indoor unit 10 ft / 3 m away from TV or radio appliances.

NOTE: Radio interference may occur if appliances are placed too close to each other.

- Do not install in a laundry room or by a swimming pool.
- There should not be any heat source near the indoor unit.
- Do not install the indoor unit near the door way.

⚠ To prevent the indoor unit from falling down and blocking exit way in case of an emergency such as fire or earthquake etc.

### Picking a Installation Location for the Outdoor Unit

- Do not install the outdoor unit near a heat source, steam, or flammable gas.
- Do not install the outdoor unit in windy or dusty locations.
- Do not install the outdoor unit in places where people often pass.
- Avoid installing the outdoor unit in places where it will be exposed to direct sunlight.

NOTE: If necessary, build a protection that does not interfere with the airflow.

- Make sure there is enough space around the outdoor unit to circulate air.

Page 10

- Outdoor unit must be placed in a safe and solid location.
- The outdoor unit should ideally be placed on a elevated concrete pad.
- If installing in snowy region, it is recommended the outdoor unit to be installed above the seasonal snow level.



- Before installation, make sure the AC system is placed on a flat and stable platform in its upright position for at least 6 hours to prevent lubricating oil from damaging the compressor.

# Indoor Unit Installation

## Install the Mounting Bracket

1. Locate the studs and electrical wires inside the wall. Then use the template included with the indoor unit or the etched marking on the mounting plate to determine the exact mounting location.
2. Use a spirit level to level the mounting plate on the wall. Then mark out the screw hole positions.
3. Insert wall anchors into the holes and affix the mounting plate to the wall using screws.  
Use a wood screw if the hole position is directly on a wood stud.

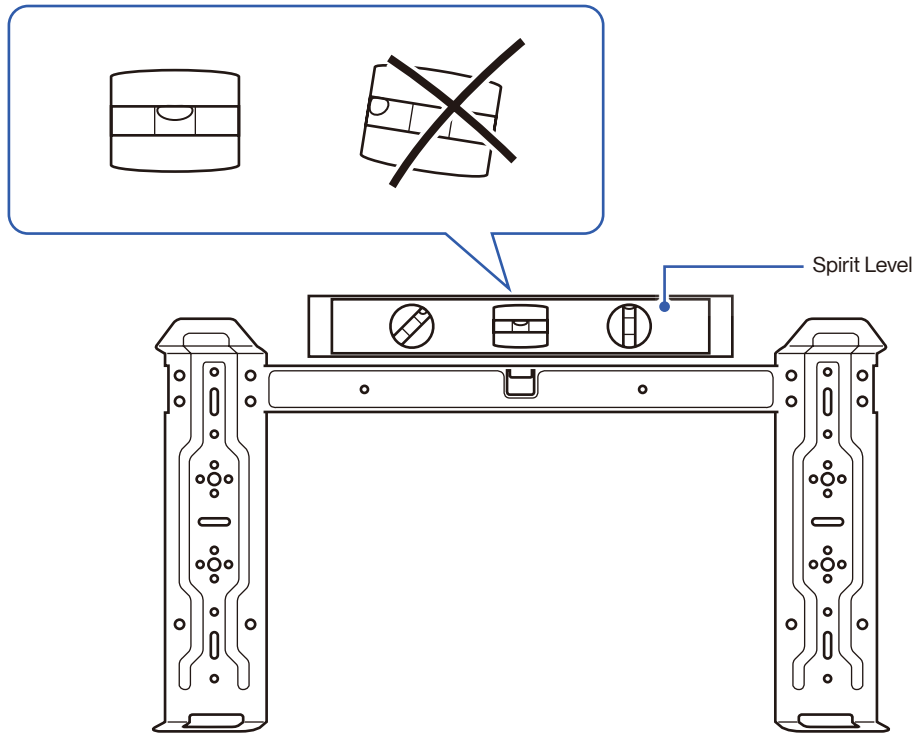

### Hollow Drywall

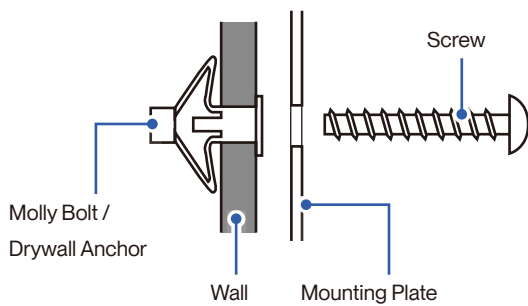

### Wood Stud

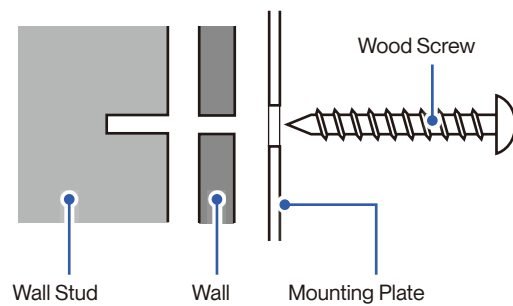

- You must use the correct wall anchor according to the type of the wall.

## Indoor Unit Installation

### Drill Wall Hole and Insert Wall Sleeve

- Pick 1 of the 3 piping positions on your indoor unit.

#### Piping Position

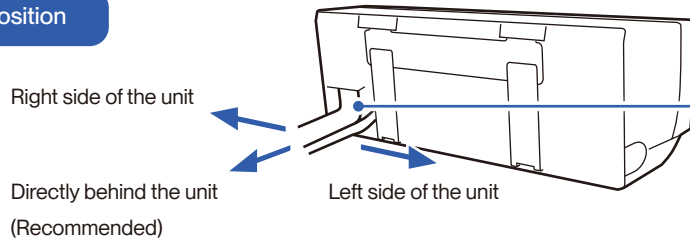

#### QUICK TIPS

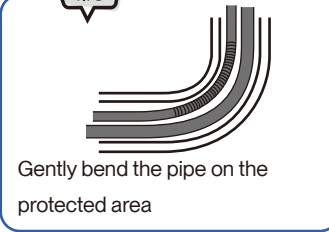

- Mark the position on the wall.

#### Example of Wall Hole Position with Piping Directly Behind the Indoor Unit

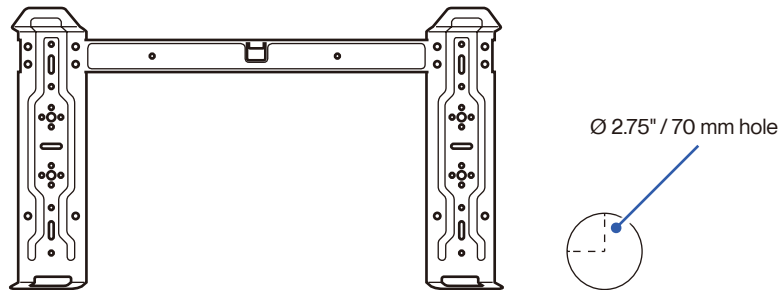

#### WARNING

- Make sure there is no building structure pillar, stud, electrical wire, or any water pipes in the way of the drill hole. Drilling into electrical wires or water pipes inside the wall may cause electric shock, fire, or water damage.

- Drill a 2.75" / 70 mm wide hole from the indoor wall to the outdoor wall. The hole must be slanted downward with a small angle.
- Insert the wall sleeve and wall cover into the wall. Then seal off gaps with putty or caulk.

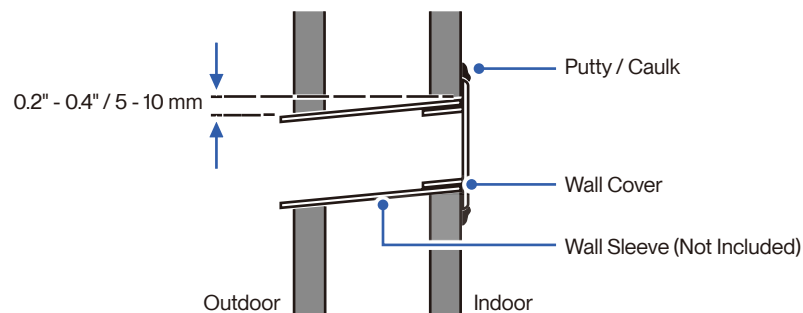

- Always insert the sleeve into the wall hole and seal the surrounding with putty / caulk. This will prevent water, insects, or small animals from getting into the house.

# Indoor Unit Installation

## Connect the Indoor Unit Drain Hose

1. Connect the drainage hose to the indoor unit drainage port.

NOTE: In some models, drainage ports are available on both sides of the indoor unit. You can choose one side to attach the drain hose and insert a rubber plug on the unused port. Always pick the side closer to the wall hole.

2. Make sure the joint is firmly connected and has a good seal.
3. Wrap the joint with Teflon tape to prevent any possible leak.

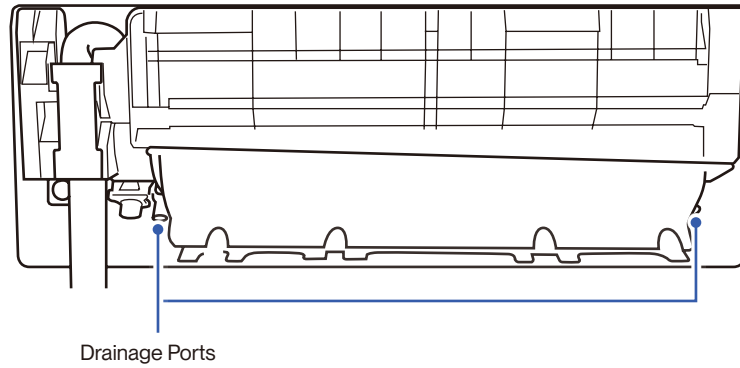

### Drain Hose Installation

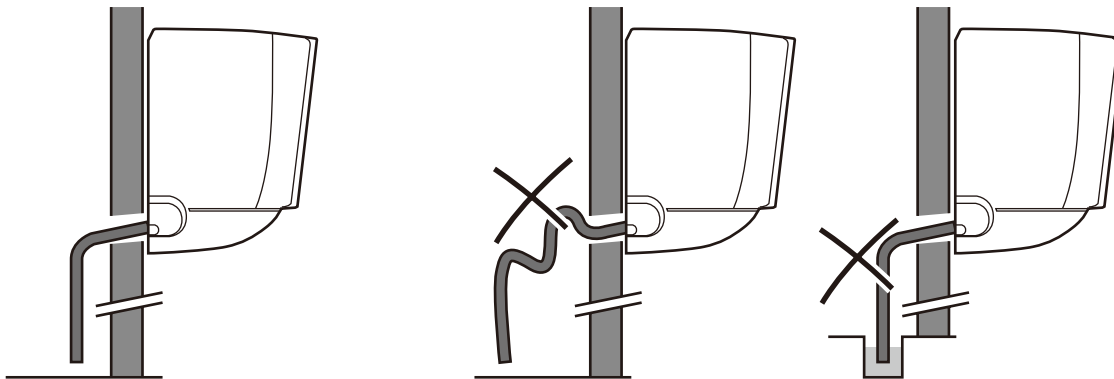

! Drain hose must be slanted downward and leave a small gap between the ground and the hose.

! Avoid having bends or dents on the drain hose.  
Do not leave the end of the hose into drainage gutter.

## Indoor Unit Installation

### Pass Electrical Cable Through the Indoor Unit

1. Open the front panel of the indoor unit.
2. Remove the control box cover from the control box.
3. Pass the electric cable (communication cable) from the back of the indoor unit to the control box.
4. Leave enough length of the electric wire in the control box for connection in a later step.

Page 23

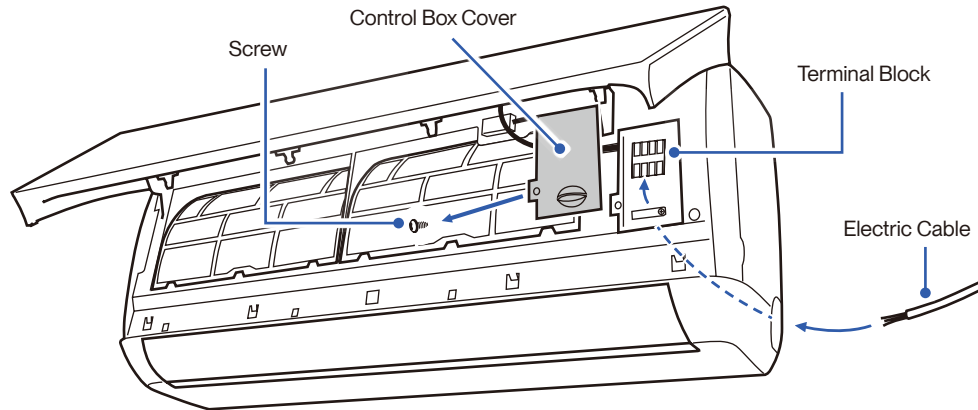

### Bundle the Indoor Unit Refrigerant Pipes, Hose, and Cable

Refrigerant Pipes, drain hose, and electric cable must be properly arranged and bundled with insulation tape before passing them through the wall hole.

1. Arrange the refrigerant pipes, drain hose, and electric cable according to the image below.
2. Wrap the bundle with insulation pipe.

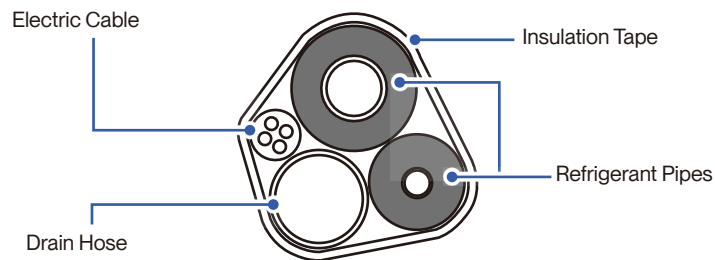

- Drain hose must be positioned at the bottom to prevent water leakage.

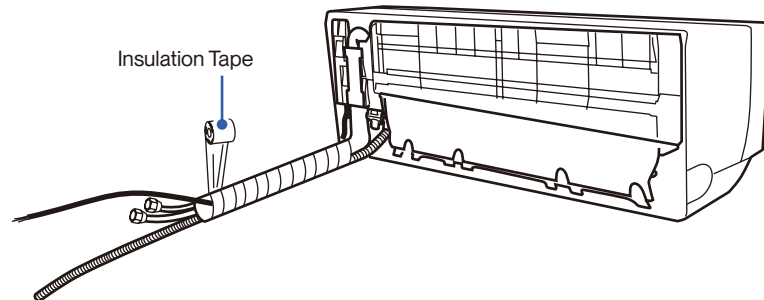

# Indoor Unit Installation

## Pass Line Set Through Wall Hole and Mount Indoor Unit

1. Carefully pass the line set bundle through the wall hole.
2. Hook the top of the indoor unit on the mounting plate.  
Push the unit lightly left and right to make sure it is firmly hooked on the mounting plate.
3. Push down the bottom of the indoor unit and snap into the mounting plate.

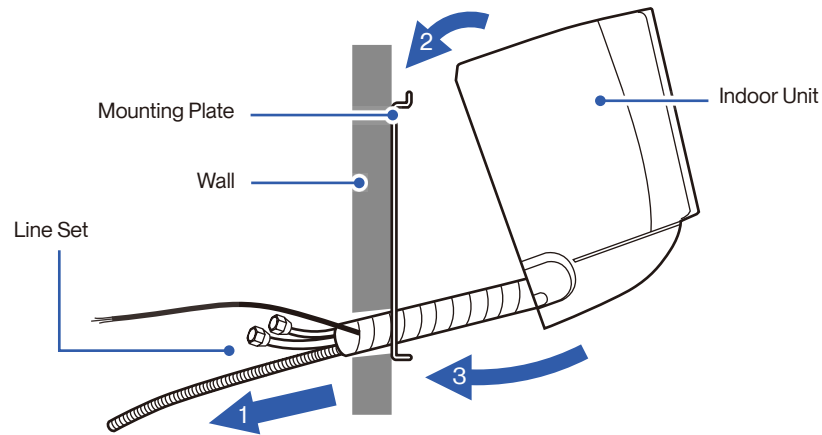

## Pass Line Set Through Wall Hole and Mount Indoor Unit (Left Piping Direction)

If you choose to have the piping direction on the left side of the indoor unit,

1. Carefully pass the drain hose and electric cable through the wall hole.
2. Hook the top of the indoor unit on the mounting plate.  
Push the unit lightly left and right to make sure it is firmly hooked on the mounting plate.
3. Place a wedge or foam block or something slightly soft between the mounting plate and the indoor unit for an easier installation process in later steps.

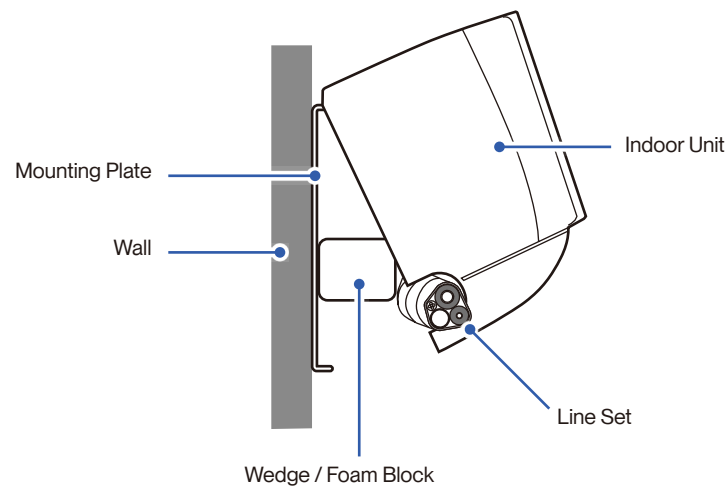

- The indoor unit is not secured in place at this step for left side piping direction installation. Handle the unit and line set with caution. It is recommended to have a person looking after the unit and make sure it does not fall during the later installation process.

## Outdoor Unit Installation

### Secure the Outdoor Unit (Ground Installation)

1. Place a concrete pad on the installation location.  
NOTE: You do not need a concrete pad if the ground is concrete.
2. Mount the indoor unit on a mounting stand or base kit.  
NOTE: Rubber foot pads can be placed between the outdoor unit and the mounting kit to reduce vibration or noise.
3. Drill holes on the concrete pad or concrete ground.
4. Secure the mounting stand or base kit on the concrete with concrete anchor bolts.

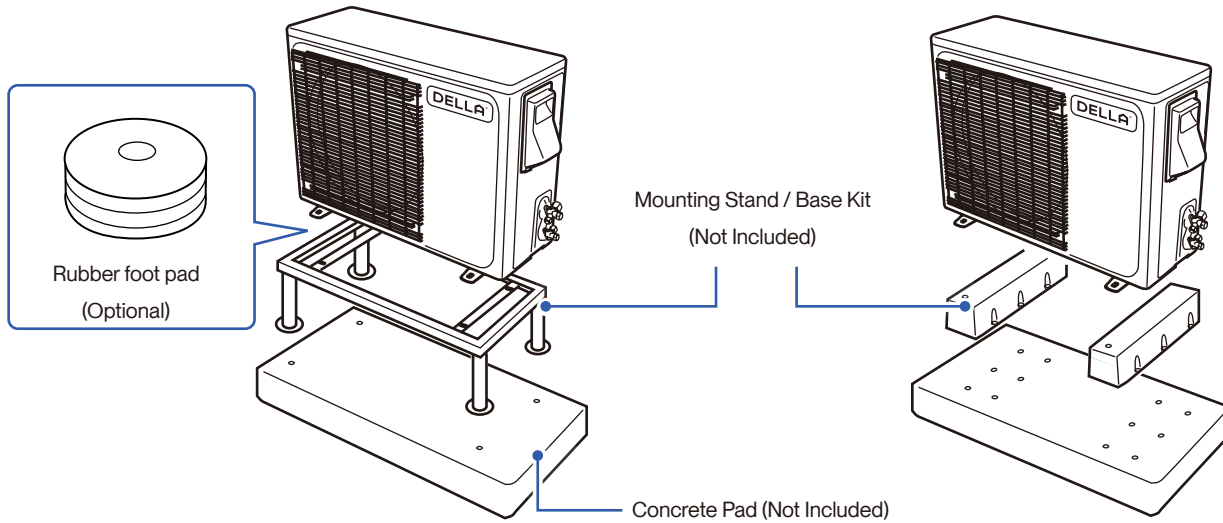

- Outdoor unit should be installed on a elevated mounting stand with snow cover if using in a snowy region.

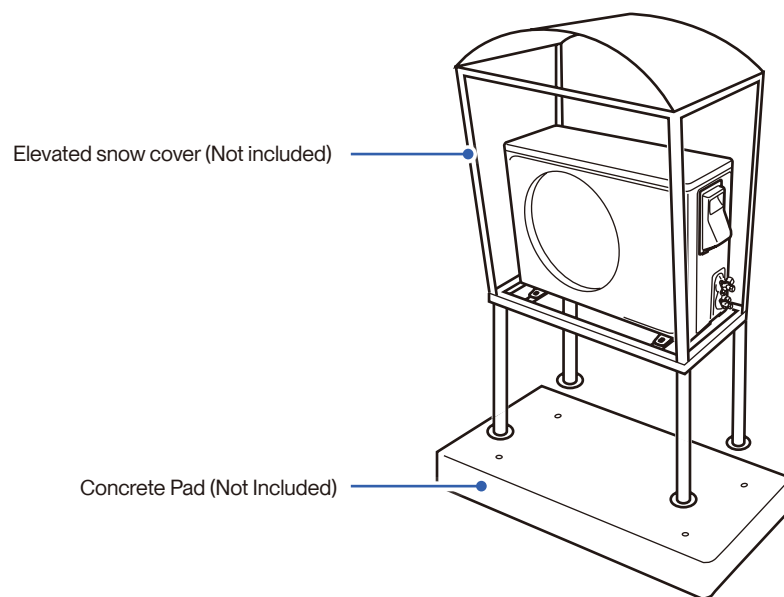

## Outdoor Unit Installation

### Secure the Outdoor Unit (Wall Installation)

The outdoor unit can be fixed on a wall mounting bracket if there is no ground mounting option.

1. Measure the distance between the outdoor unit's legs.
2. Mount the wall mounting bracket on the wall.
3. Secure the outdoor unit on the wall mounting bracket.

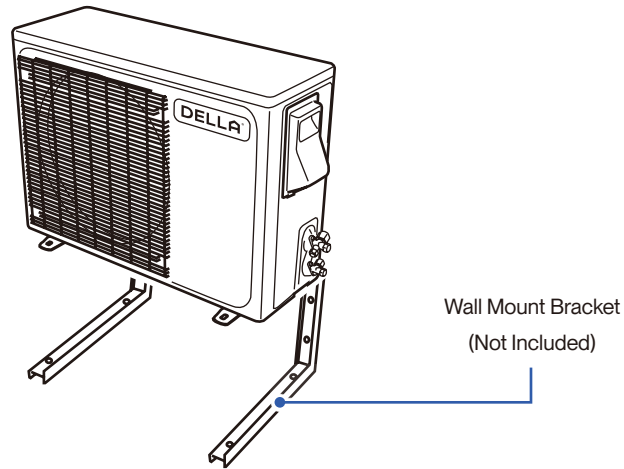

- The wall mounting bracket and the wall must be able to support at least 4 times the weight of the outdoor unit.

### Attach Drainage Port and Hose

Outdoor unit drainage helps prevent condensation or frost inside the unit during cold weather.

1. Drainage joint installation is recommended for heat pump models.
2. Insert a  $\varnothing 25$  drainage joint into the bottom hole of the outdoor unit.
3. Connect one end of the drain hose (not included) to the joint and the other end to your desired drainage point.

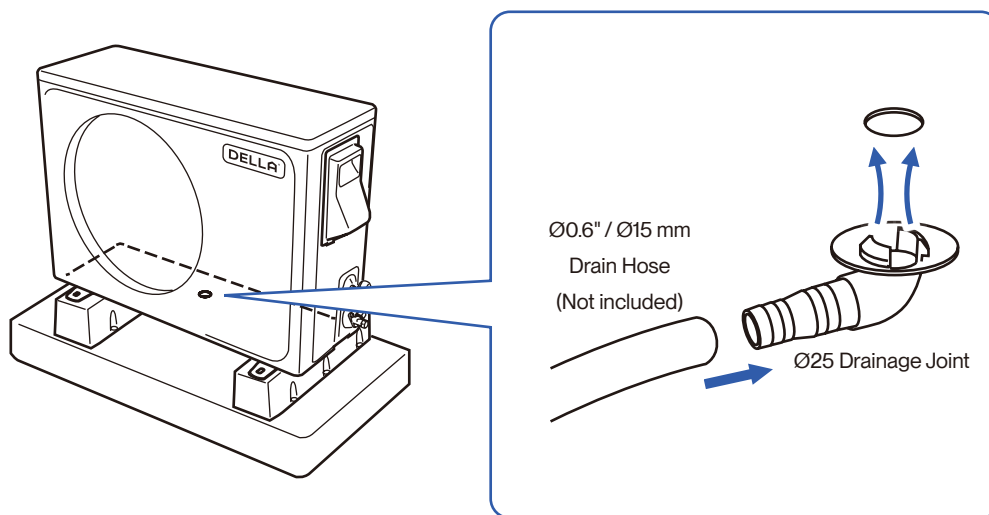

## Indoor and Outdoor Unit Installation

### Preparing the Refrigerant Pipe

1. Unroll the included refrigerant pipe.

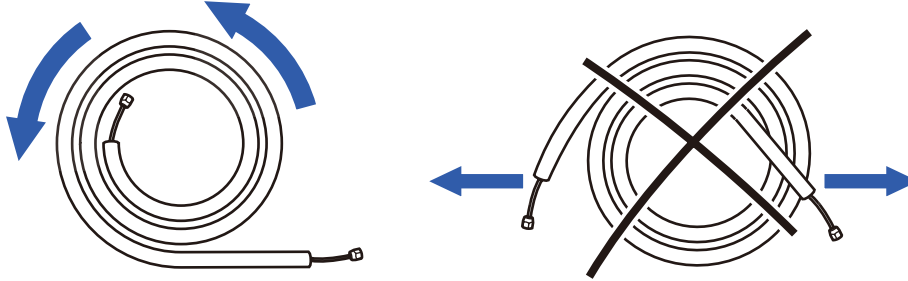

- Do not pull the refrigerant pipe to prevent the pipe from kinking or bending.

2. Remove the cover and make sure the ports are clean and smooth.

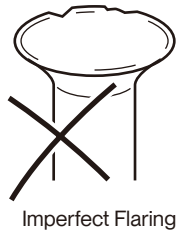

Imperfect Flaring



Dirty Flaring

3. In the case of a imperfect flaring or the pipe needs to be shorten for the installation, refrigerant pipe should be cut and flare by qualified technician.

Page 21

#### QUICK TIPS

- Use a pipe bender or spring bender to shape the refrigerant pipes along wall and corners. Bending the pipe without bending tools would easily kink or damage the pipe, which would cause refrigerant starvation, or leakage in the system.

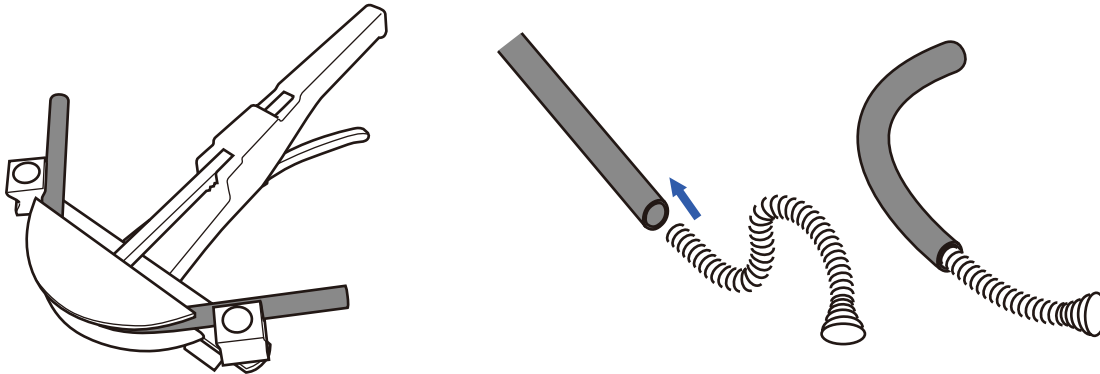

# Indoor and Outdoor Unit Installation

## Cutting and Flaring Refrigerant Pipe



**WARNING**

- Any refrigerant pipe alteration should only be done by qualified technician. Incorrect work may cause refrigerant leak, reduce cooling / heating efficiency, damage to the unit. Warranty does not cover any damage(s) caused by incorrect refrigerant pipe alteration.

1. Cut the copper pipe with a pipe cutter.
2. Remove any burrs or rough edges with a reamer with the pipe facing downward.  
NOTE: The opening of the pipe must face toward the ground to prevent chips or dust from entering the pipe.
3. Insert the flare nut to the pipe.
4. Use the flaring tool to flare the copper pipe. The flaring angle must match to that of the refrigerant lines from the unit.

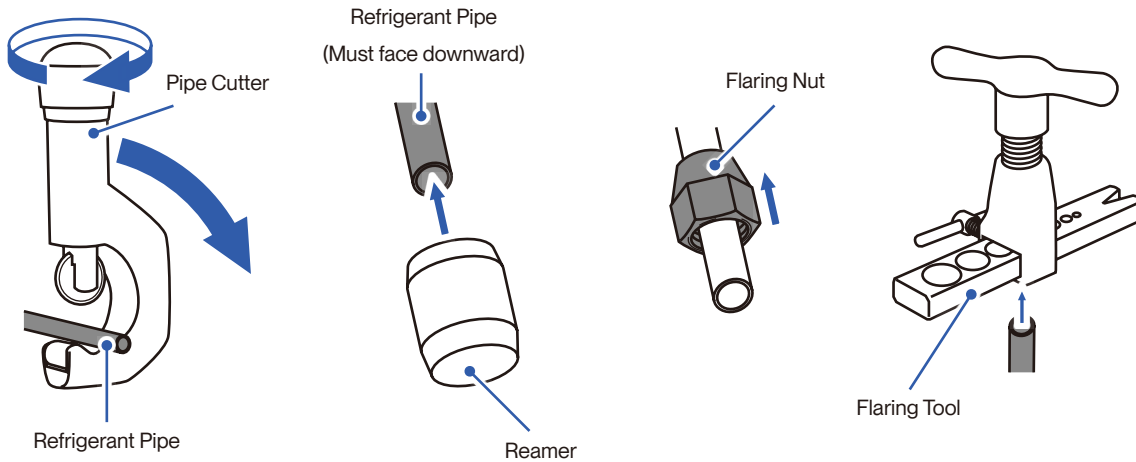

## Indoor and Outdoor Unit Installation

### Connect the Refrigerant Pipes to the Indoor Unit

- Align the refrigerant pipes to that from the indoor unit, then tighten the nut by hand.
- Use a torque wrench to tighten the nut according to the torque requirement.

**QUICK TIPS**

- A thin layer of nylog can be applied to the inside of the flare to provide better seal. (OPTIONAL)
- Make sure no nylog is on the outside of the flare.

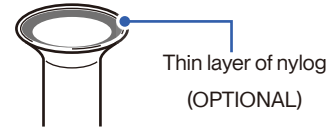

### Connect the Refrigerant Pipes to the Outdoor Unit

- Unscrew the screws on the valve cover, press it down gently and remove the cover from the outdoor unit.
- Remove plastic caps from the end of the valves.
- Align the refrigerant pipes straight to the outdoor unit valve, then tighten the nut by hand.
- Use a torque wrench to tighten the nut according to the torque requirement.

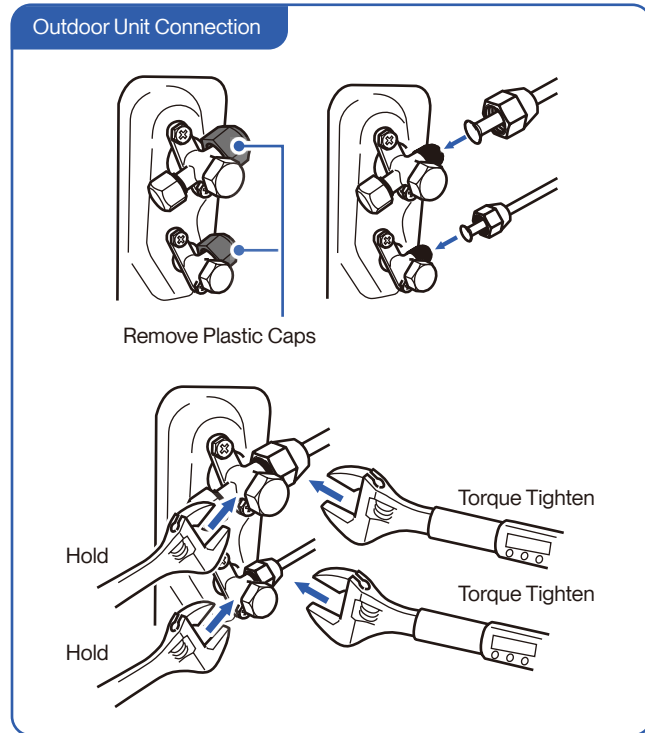
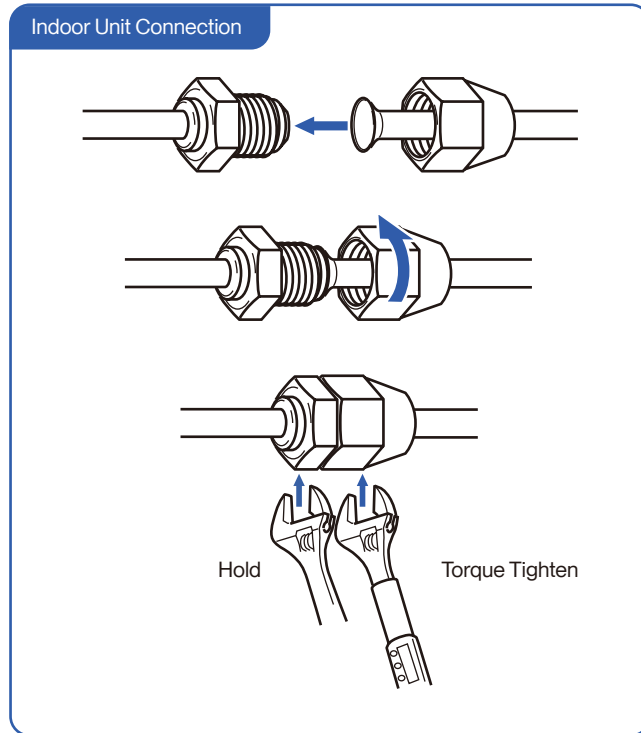

Pipe Diameter	1/4"	3/8"	1/2"	5/8"
Torque Parameter	15 - 25 N-M 11.1 - 18.4 lbf-ft 1.5 - 2.5 kgf-m	35 - 40 N-M 25.8 - 29.5 lbf-ft 3.6 - 4.1 kgf-m	45 - 60 N-M 33.2 - 44.3 lbf-ft 4.6 - 6.1 kgf-m	60 - 65 N-M 44.3 - 48.0 lbf-ft 6.1 - 6.6 kgf-m



- Connection must be torque tighten to prevent leak. Do not over tighten.
- Refrigerant piping and torque requirement for specific model is on [Page 11](#).

# Indoor and Outdoor Unit Installation

## Connect the Electrical Wire



**WARNING**

- Electrical wiring must be done by a qualified technician or electrician. Failing to connect the wires correctly will cause short circuit, a fire, and property damage.
- Do not use the communication cable as power supply cable.

1. Unscrew the cable clamp in the indoor unit.
2. Connect wires to the corresponding terminal and secure the cable using the cable clamp.
3. Reinstall the control box cover and close the indoor unit's front panel.
4. Unscrew the screws from the wiring cover, press the cover downward gently, and remove from the outdoor unit.
5. Unscrew the cable clamp.
6. Insert the communication cable from the indoor unit through the opening on the cover, then connect the wires to the outdoor unit terminal.
7. Insert power supply cable (not included) to the opening on the cover, then connect the wires to the outdoor unit terminal.
8. Turn off any power from the power supply, and connect the wires to the power supply circuit box.  
Exact power supply cable and breaker size requirement on [Page 11](#)
9. Reinstall the wiring cover to its original place.

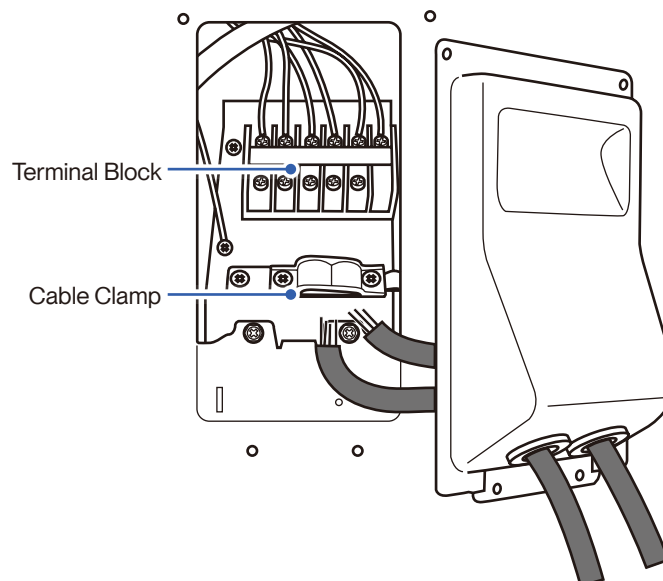
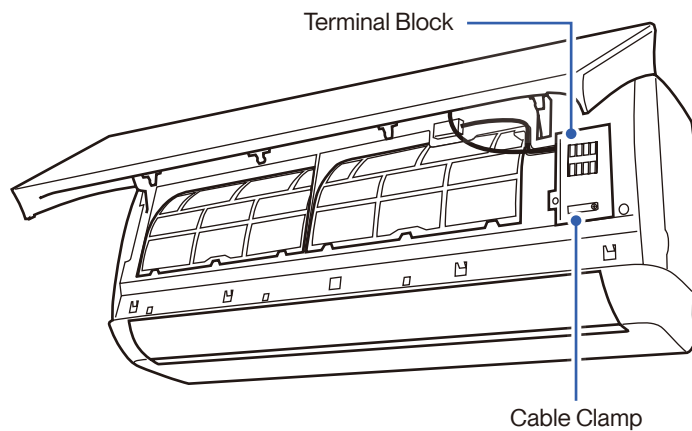

## Indoor and Outdoor Unit Installation

Connect the Electrical Wire

For 115V Unit

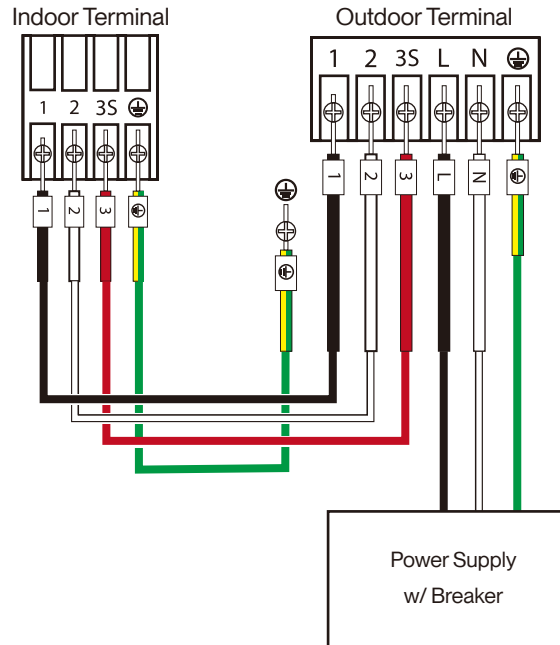

For 220V Unit

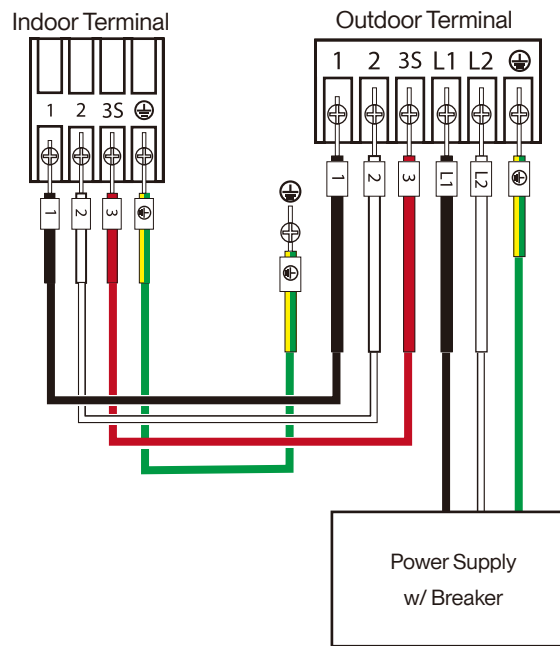

Installation  
Installation

# Indoor and Outdoor Unit Installation

## Indoor Unit Circuit Diagram

- 048-MS-9K1VRH-20S-JPB-IN
- 048-MS-9K2VRH-19S-JPB-IN
- 048-MS-12K1VRH-20S-JPB-IN
- 048-MS-12K2VRH-19S-JPB-IN
- 048-MS-18K2VRH-19S-JPB-IN
- 048-MS-24K2VRH-19S-JPB-IN

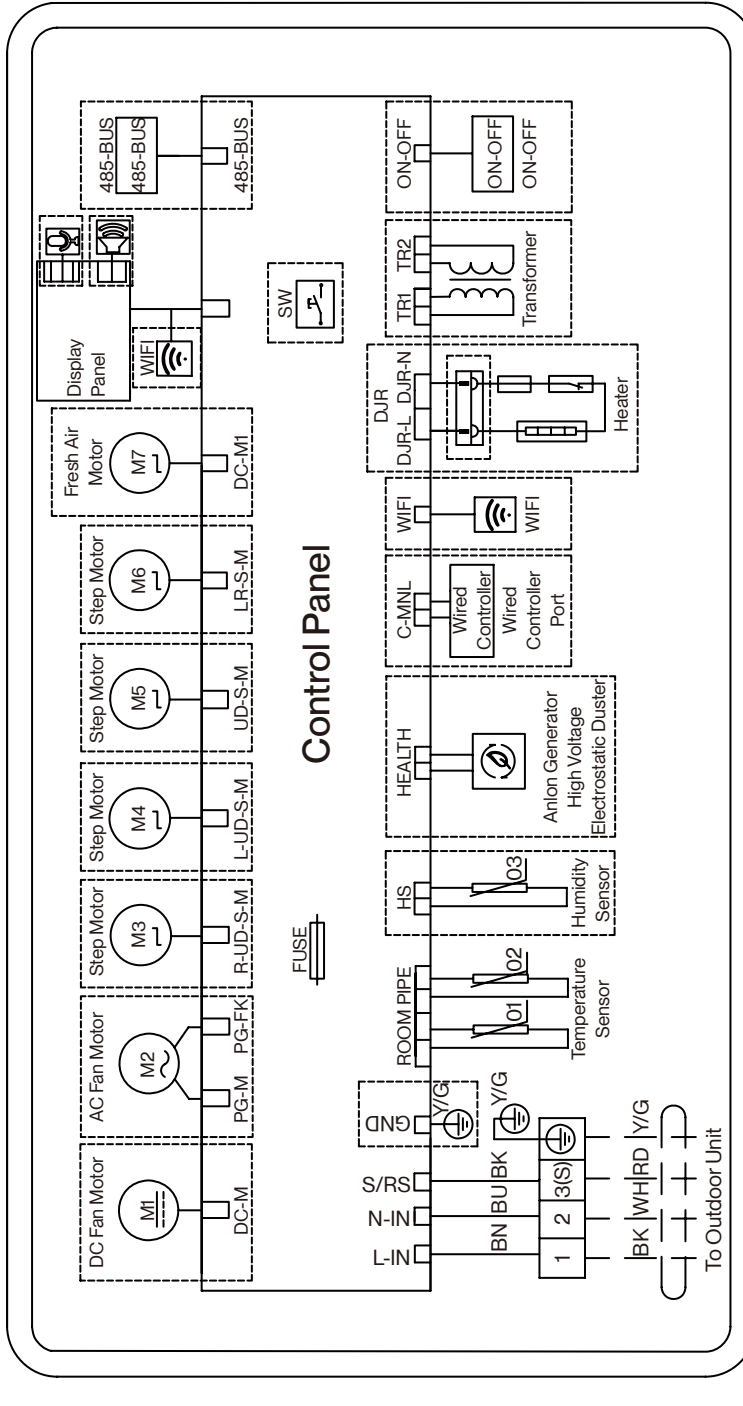

Installation  
Installation

## Indoor and Outdoor Unit Installation

### Outdoor Unit Circuit Diagram

048-MS-9K1VRH-20S-OUT

048-MS-12K1VRH-20S-OUT

Installation  
Installation

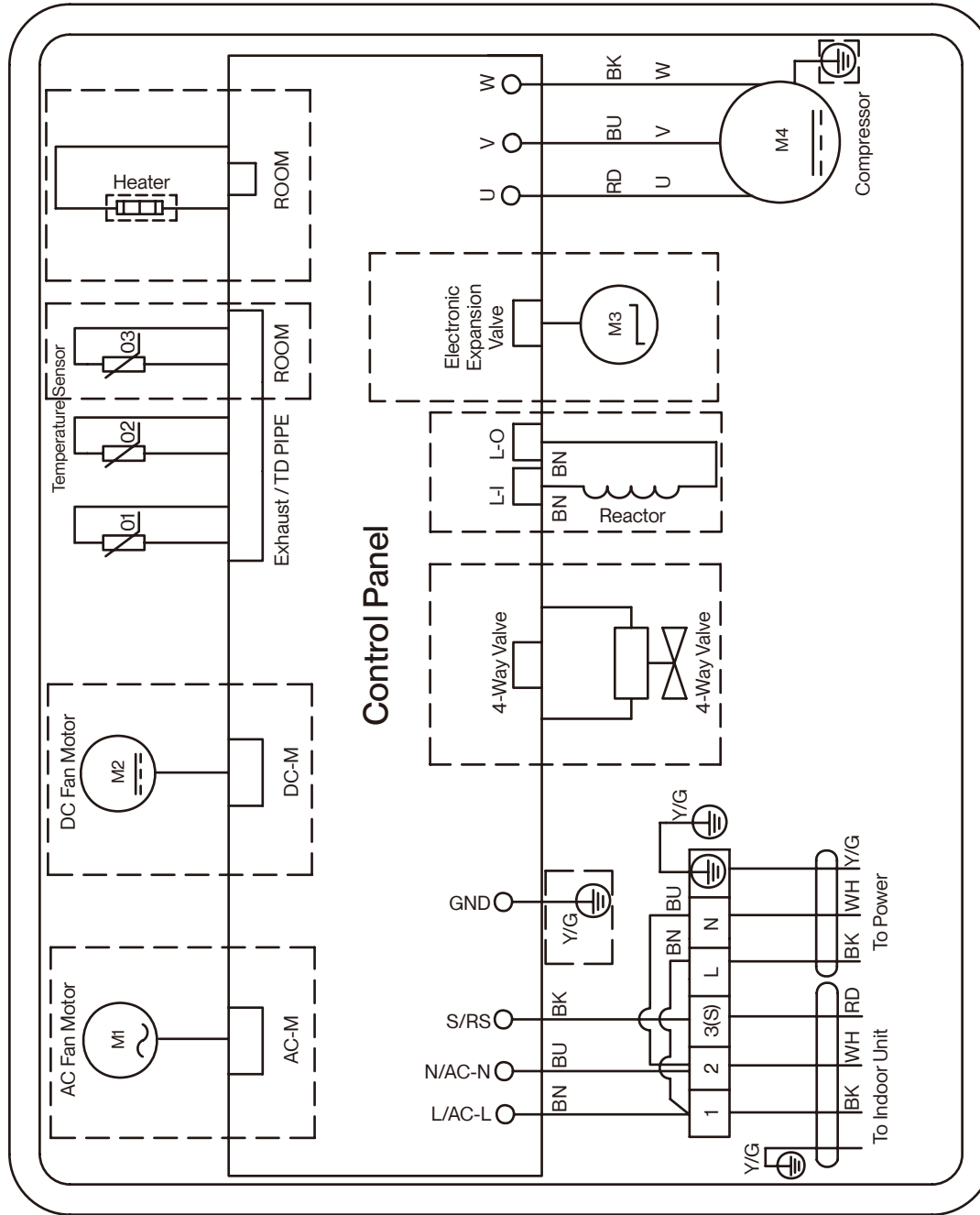

# Indoor and Outdoor Unit Installation

## Outdoor Unit Circuit Diagram

- 048-MS-9K2VRH-19S-OUT
- 048-MS-12K2VRH-19S-OUT
- 048-MS-18K2VRH-19S-OUT
- 048-MS-24K2VRH-19S-OUT

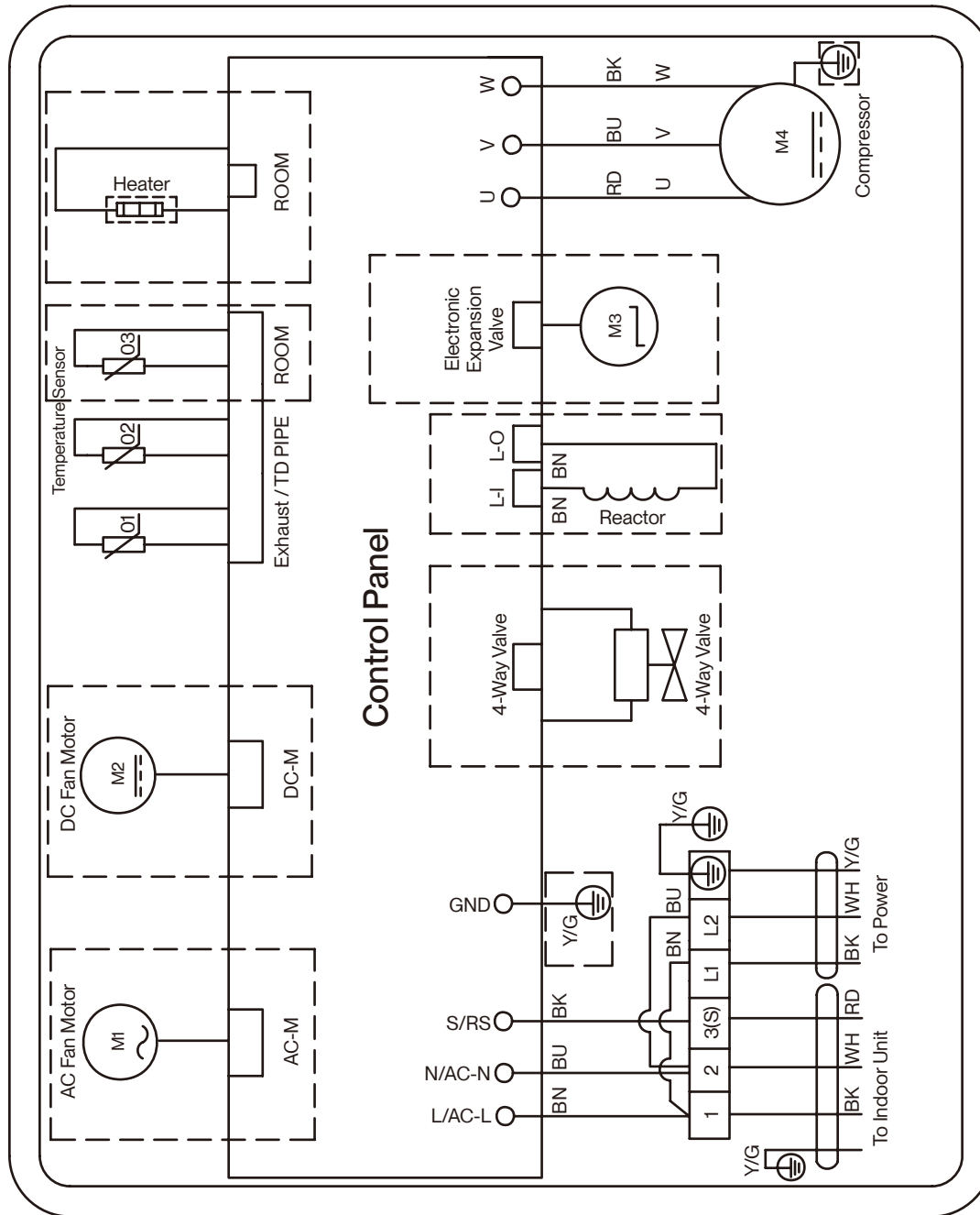

Installation  
Installation

## Indoor and Outdoor Unit Installation

### Vacuum Pumping, Leak Test (Using Micron Gauge) \*RECOMMENDED, and Adjust Refrigerant Level

1. Remove the protective caps from the service port, low-pressure valve (Lo-R), and high-pressure valve (Hi-R).
2. Connect the charging hose with a push pin to the service port.
3. Connect a vacuum pump to the other end of the charging hose and the micron gauge in between the service port and the pump.
4. Open the valve adapter on the charging set, then turn on the vacuum pump to vacuum the system.
5. Let the vacuum pump run until the micron gauge indicate the value of 500 micron or lower.
6. Close the valve adapter on the charging set and turn off the vacuum pump.
7. Leave the system connected with the micron gauge for 5 minutes, then make sure the gauge indication does not exceed 500 micron.  
**NOTE:** In the case of a leak, and the micron level increases above 500 micron, reconnect all the connection joints on the refrigerant line, and redo the vacuum pumping.
8. Disconnect the pressure hose and the micron gauge from the service port.
9. The air conditioner comes with enough refrigerant for the standard length pipe set, add refrigerant charge if you use a lengthened refrigerant line.  
[Page 11](#)
10. Turn on the air conditioner and confirm it can power on properly, and then turn it off.  
[Page 42](#)
11. Fully open the low pressure valve (Lo-R) and high pressure valve (Hi-R)
12. Put the protective caps back on the service, low-pressure valve, and high-pressure valve.
13. Tighten the caps.



- Only add refrigerant if you use a lengthened refrigerant line. There is no need to adjust or recover any amount of refrigerant if you use a standard or shortened refrigerant line.
- Do not open the refrigerant valve before vacuum pumping is completed.
- Stop and disconnect the vacuum pump from the system before opening the refrigerant valve.
- Each indoor unit connected to the multizone outdoor unit must be vacuumed respectively.

# Indoor and Outdoor Unit Installation

## Micron Gauge Connection

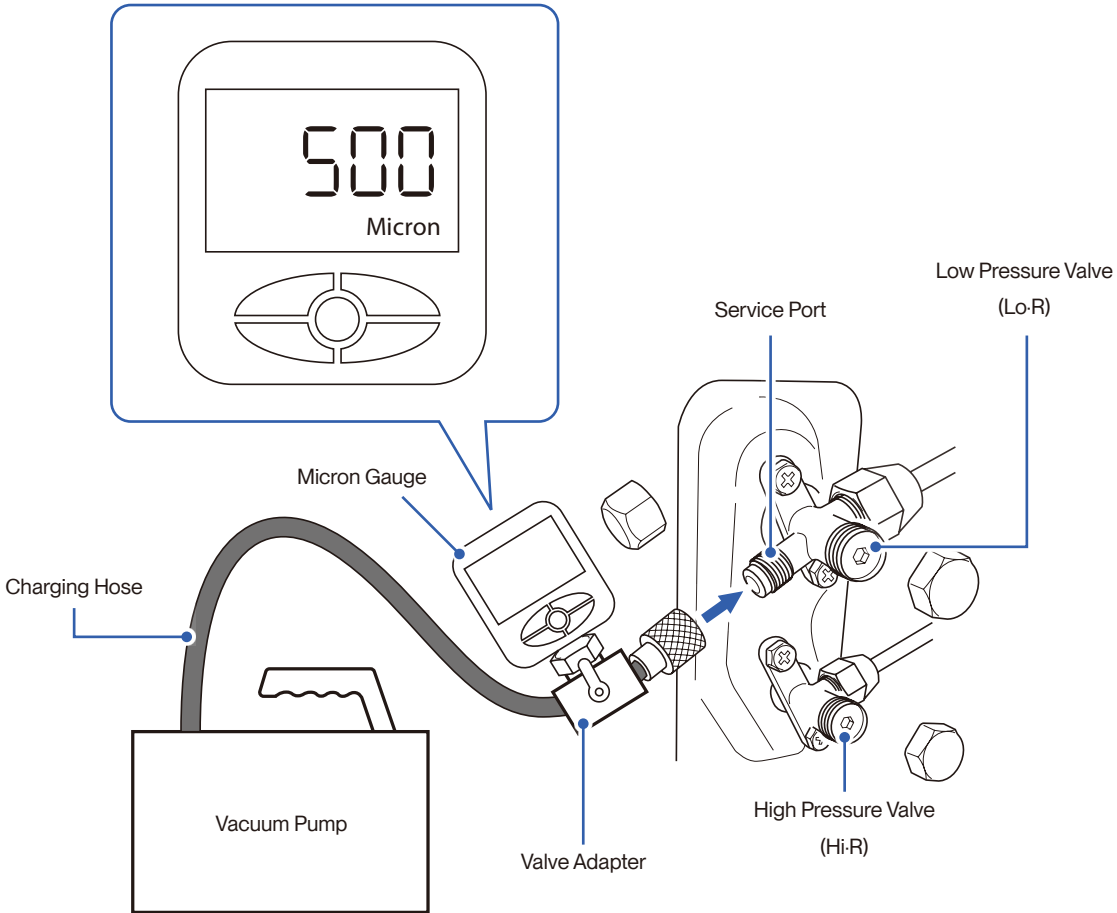

**WARNING**

- When evacuating mini-split system with A2L rated refrigerant, an A2L rated vacuum pump must be used. If an A2L rated pump is not available, vacuuming must be done outdoor only. Failure to follow this instruction may result in fire or explosion hazard.

## Indoor and Outdoor Unit Installation

### Vacuum Pumping, Leak Test (Using Manifold Gauge), and Adjust Refrigerant Level



- Analog manifold gauge is less accurate and measure vacuum at a lower resolution than a digital micron gauge. DELLA recommend using micron gauge for vacuum pumping mentioned on [Page 28](#).

- Remove the protective caps from the service port, low-pressure valve (Lo-R), and high-pressure valve (Hi-R).
- Connect the pressure hose with a push pin from the manifold gauge to the service port.
- Connect the charging hose from the manifold gauge to the vacuum pump.
- OPEN the low-pressure valve (Lo-M) and CLOSE the high pressure valve (Hi-M) on the manifold gauge.
- Turn on the vacuum pump to vacuum the system.
- Let the vacuum pump run for at least 15 minutes and make sure the gauge indicates  $-0.1$  Mpa ( $-76$  cmHg).  
NOTE: Depending on your refrigerant line set length and vacuum pump power, it might takes longer time.
- Close the pressure valve (Lo-M) and turn off the vacuum pump.
- Leave the system connected with the manifold gauge for 5 minutes, then make sure the gauge indication does not exceed  $0.005$  Mpa.  
NOTE: In the case of a leak, and the pressure value increases, reconnect all the connection joints on the refrigerant line, and redo the vacuum pumping.
- Open the high-pressure valve (Hi-R) for  $1/4$  turn, then close the valve after 5 seconds.
- Check all connection joints with refrigerant leak detector or liquid leak detector.
- The air conditioner comes with enough refrigerant for the standard length pipe set, add refrigerant charge if you use a lengthened refrigerant line.  
[Page 11](#)
- Turn on the air conditioner and confirm it can power on properly, and then turn it off.  
[Page 42](#)
- Disconnect the pressure hose from the service port, then fully open the low pressure valve (Lo-R) and high pressure valve (Hi-R).
- Put the protective caps back on the service, low-pressure valve, and high-pressure valve.
- Tighten the caps.



- Only add refrigerant if you use a lengthened refrigerant line. There is no need to adjust or recover any amount refrigerant if you use a standard or shortened refrigerant line.
- Do not open the refrigerant valve before vacuum pumping is completed.
- Stop and disconnect the vacuum pump from the system before opening the refrigerant valve.
- Each indoor unit connected to the multizone outdoor unit must vacuumed respectively.

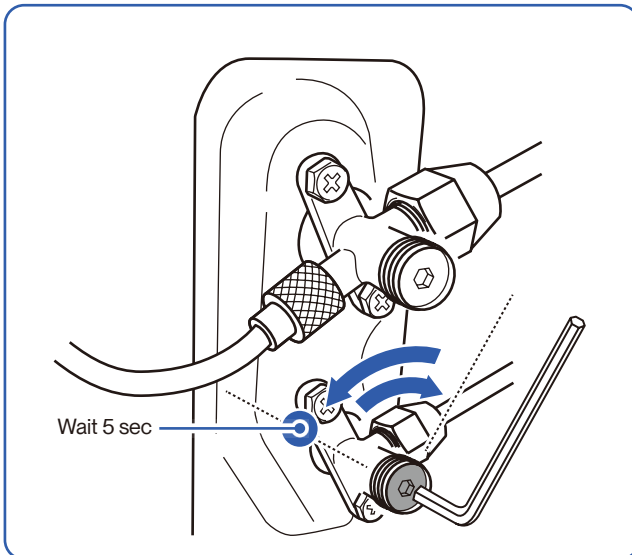

# Indoor and Outdoor Unit Installation

## Manifold Gauge Connection

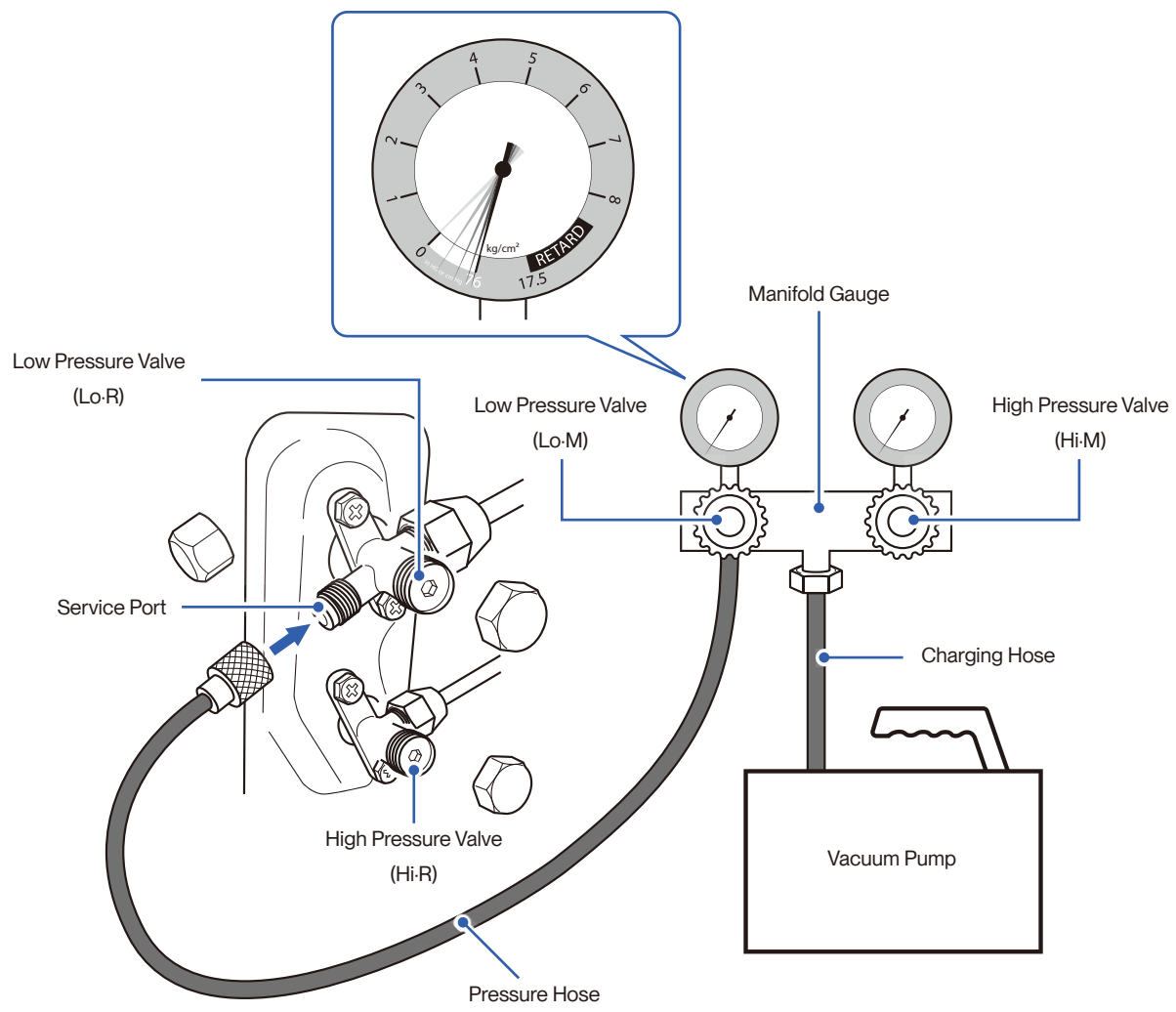

Installation  
Installation

## Finishing

### Line Set Insulation, Bundling, and Finishing Touch

Refrigerant Pipes, drain hose, and electric cable must be properly arranged and bundled with insulation tape to maximize the unit's efficiency and prevent condensation or water leak.

Installation  
Installation

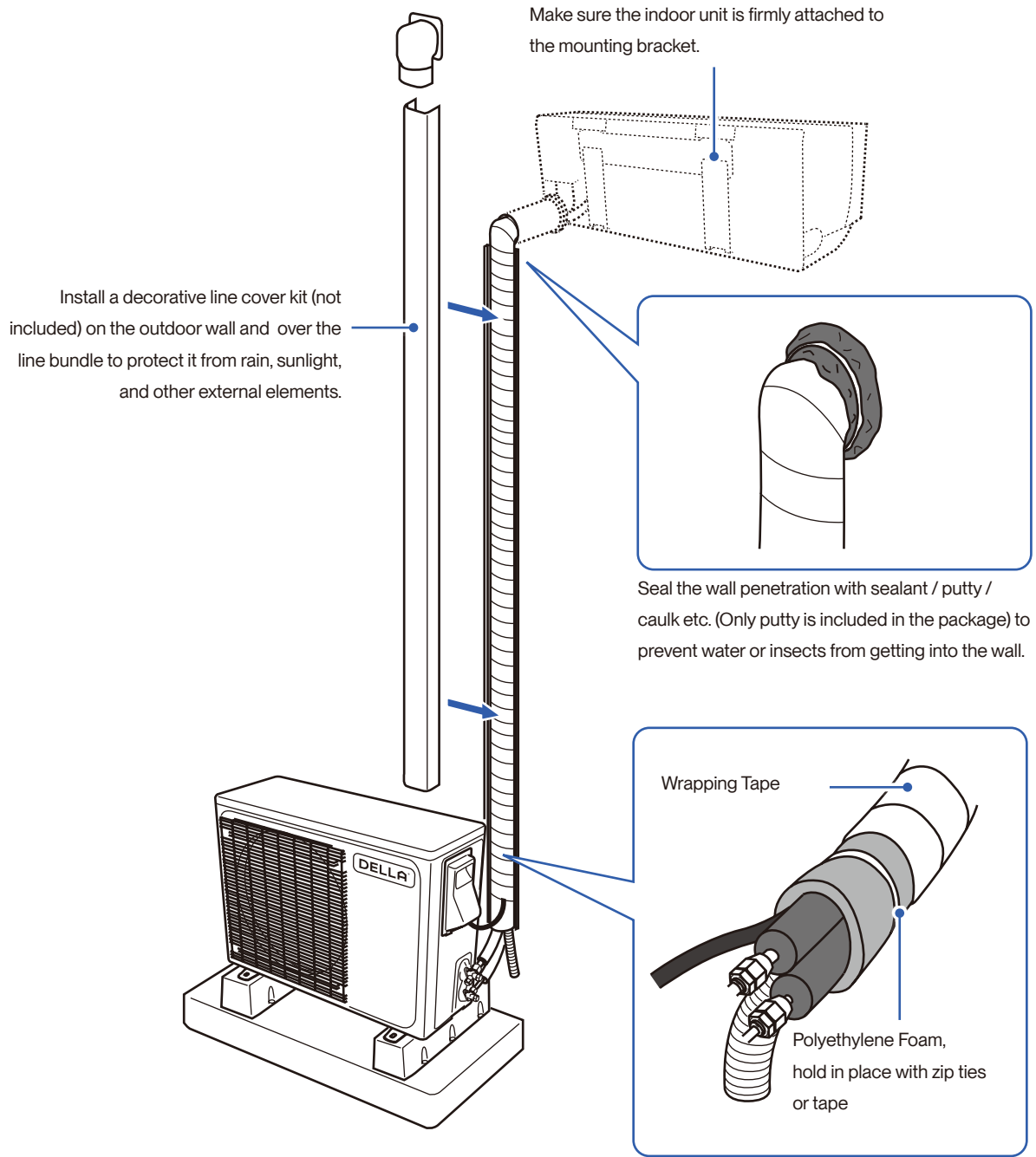

#### QUICK TIPS

- When wrapping and bundling the line set, avoid over tightening to prevent the insulating materials from over compression.
- Make sure all connection joints are properly insulated.

# Finishing

## Check List

Go through the following list and check your installation.

the check box for each confirmation.

Check List	Status
Are the indoor and outdoor unit kept at least the minimum distance away from the closest wall and obstacle?	<input type="checkbox"/>
Is the indoor mounting plate secured?	<input type="checkbox"/>
Are all the panels on the unit secured and would not fall out?	<input type="checkbox"/>
Is the drain hose properly attached?	<input type="checkbox"/>
Are the refrigerant pipes securely connected and no refrigerant leakage?	<input type="checkbox"/>
Are all pipes, hoses, and cable bundled and wrapped with insulation tape?	<input type="checkbox"/>
Is the system properly vacuumed?	<input type="checkbox"/>
Is all the wall opening sealed off?	<input type="checkbox"/>
Are the refrigerant valves fully opened?	<input type="checkbox"/>
Do the power supply and voltage match the unit rating? (Check before connecting to power supply)	<input type="checkbox"/>
Is the electrical wiring in the unit connected and secured?	<input type="checkbox"/>
Are the units properly grounded?	<input type="checkbox"/>
Is the power breaker, fuse, or protection device installed?	<input type="checkbox"/>
Can the remote control send control commands to the air conditioner?	<input type="checkbox"/>



- Any failures, accidents, or damages caused by improper installation are not covered by the warranty.

## Finishing

### Test Run

Refrigerant Pipes, drain hose, and electric cable must be properly arranged and bundled with insulation tape to maximize the unit's efficiency and prevent condensation or water leak.

1. Turn on the power supply.
2. Turn on the air conditioner using the remote control.
3. Test the unit at the lowest temperature in COOL mode.
4. Test the unit at the highest temperature in HEAT mode.
5. Test each mode for at least 8 minutes.
  - Measure the air temperature at the air outlet.
  - Check if water drains properly from the drainage hose.
  - Check if the louver and deflectors move properly.
6. If everything is operating normally, return to normal setting and turn off the air conditioner.
7. Inform the user to read the operation instruction before use, and demonstrate to the user how to use the air conditioner, the necessary knowledge of service and maintenance, and a reminder of accessories storage.



Contact us if you encounter any problems during or after the installation.



[support.dellahome.com](https://support.dellahome.com)



800-863-4143  
6:00 a.m. - 4:00 p.m. PST  
Monday - Friday



24/7 Live Chat

# Before Using

## Operation Tips

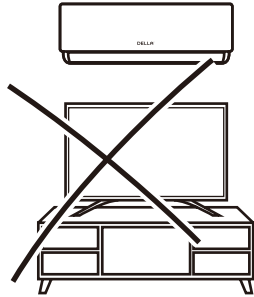

Avoid placing TV, radio or large furniture under the air conditioner.

- It may block wind flow or interfere with the remote control.

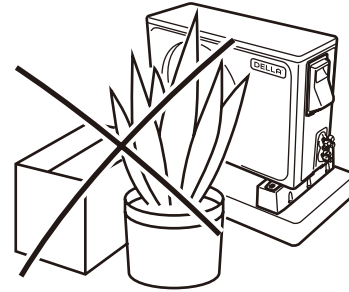

Avoid putting plants or objects around the outdoor unit.

- It may lower the air conditioner efficiency or cause malfunction.

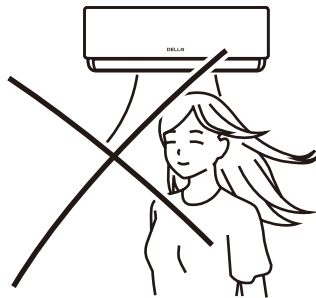

Avoid direct wind flow to people, pets, or plants.

- Expose to direct wind flow for extended period of time may have a negative impact on your health.

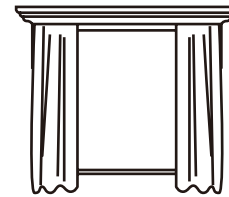

Close windows and blinds.

- The air conditioner can cool or warm the area with better efficiency.

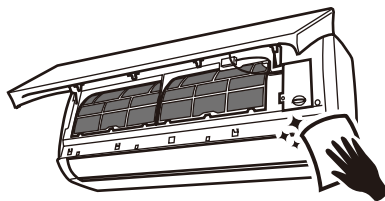

Follow cleaning and maintenance routine.

- Regular cleaning and maintenance are needed for the best efficiency and prevent bad odor or water leak.

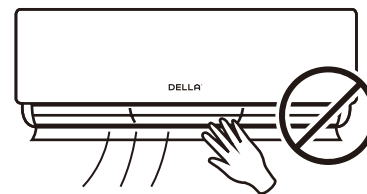

DO NOT manually adjust the deflector and flaps.

- It may cause injury to the user and damages to the air conditioner.

## Before Using

### Indoor Unit and Front Panel

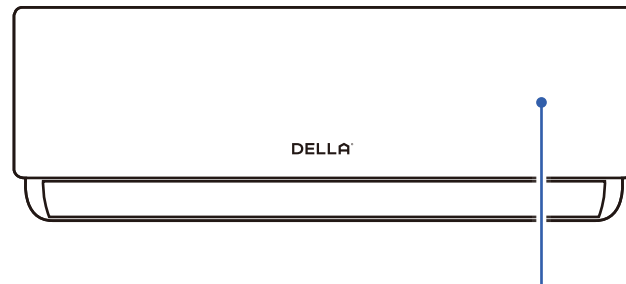
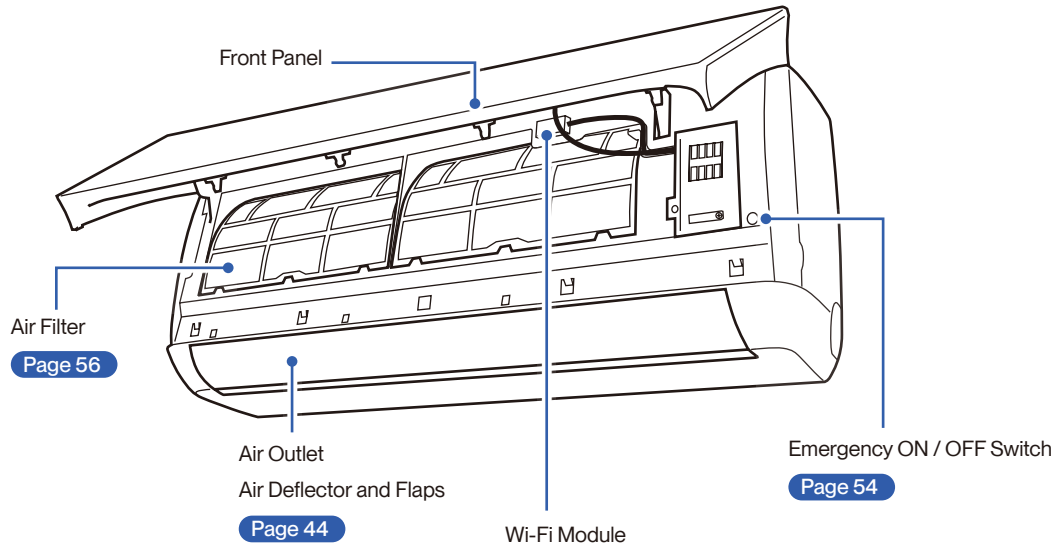

Display

LED Indicator	Function
88	Lights up when the unit is turned on and operating Indicator for temperature, timer, and error codes

NOTE: The graphical representation might have slight differences than the actual product.

## Before Using

### Remote Control (Inserting Battery)

1. Remove the back cover.
  2. Insert 2 LR03 AAA 1.5 v batteries into the remote control.
  3. Reinstall the back cover.
- After new batteries are inserted into the remote control, the display screen will lights up for 3 seconds. Leave it for 10 seconds, the display will automatically turn off.
  - The default temperature unit will automatically turn into degree Fahrenheit.  
To change temperature unit, follow instruction on [Page 50](#).



- Do not use rechargeable batteries.
- Replace the old batteries with new ones of the same type.
- Do not dispose batteries as unsorted municipal waste.

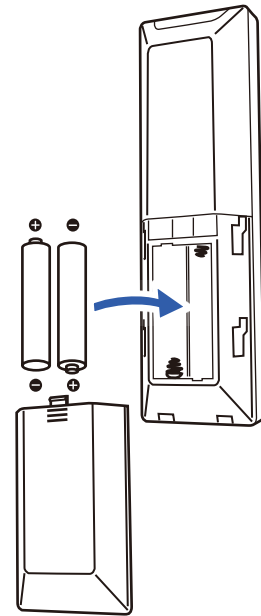

Before Using  
Before Using

### Remote Control (Remote Control Holder)

1. Attach the remote control holder to a wall by using the double sided adhesive tape or provided screws.  
NOTE: Wall anchor might needed if you install it on a dry wall.
2. Insert the remote control into the holder.



- Avoid exposing the remote control to direct sunlight.

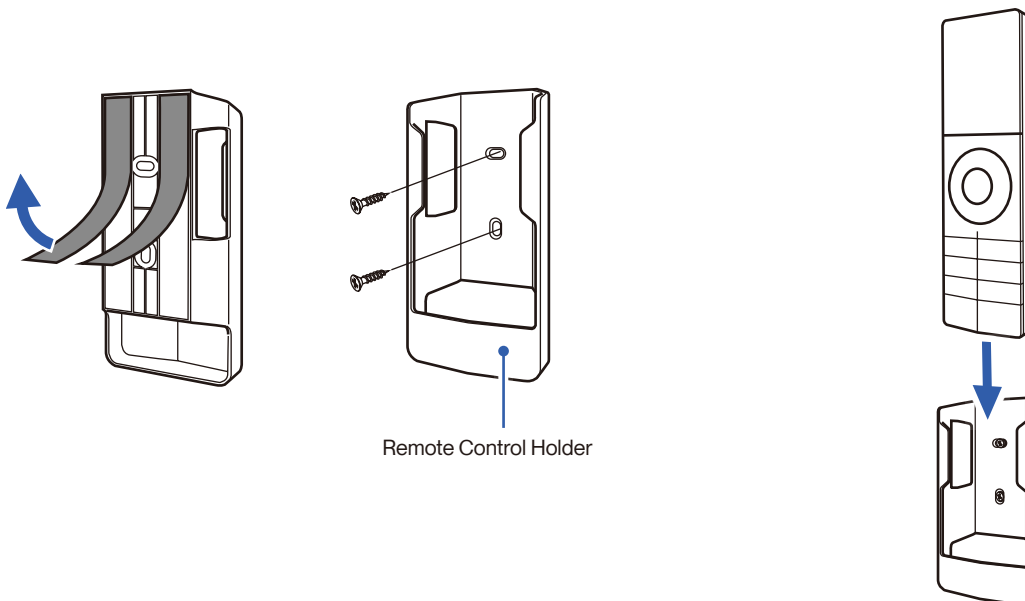



# Just Right, Always.

Made to live with you, Della puts controls in your hands so that you can easily dail in a stress-free space that helps you feel more you.



## Before Using

### Remote Control

Before Using  
Before Using

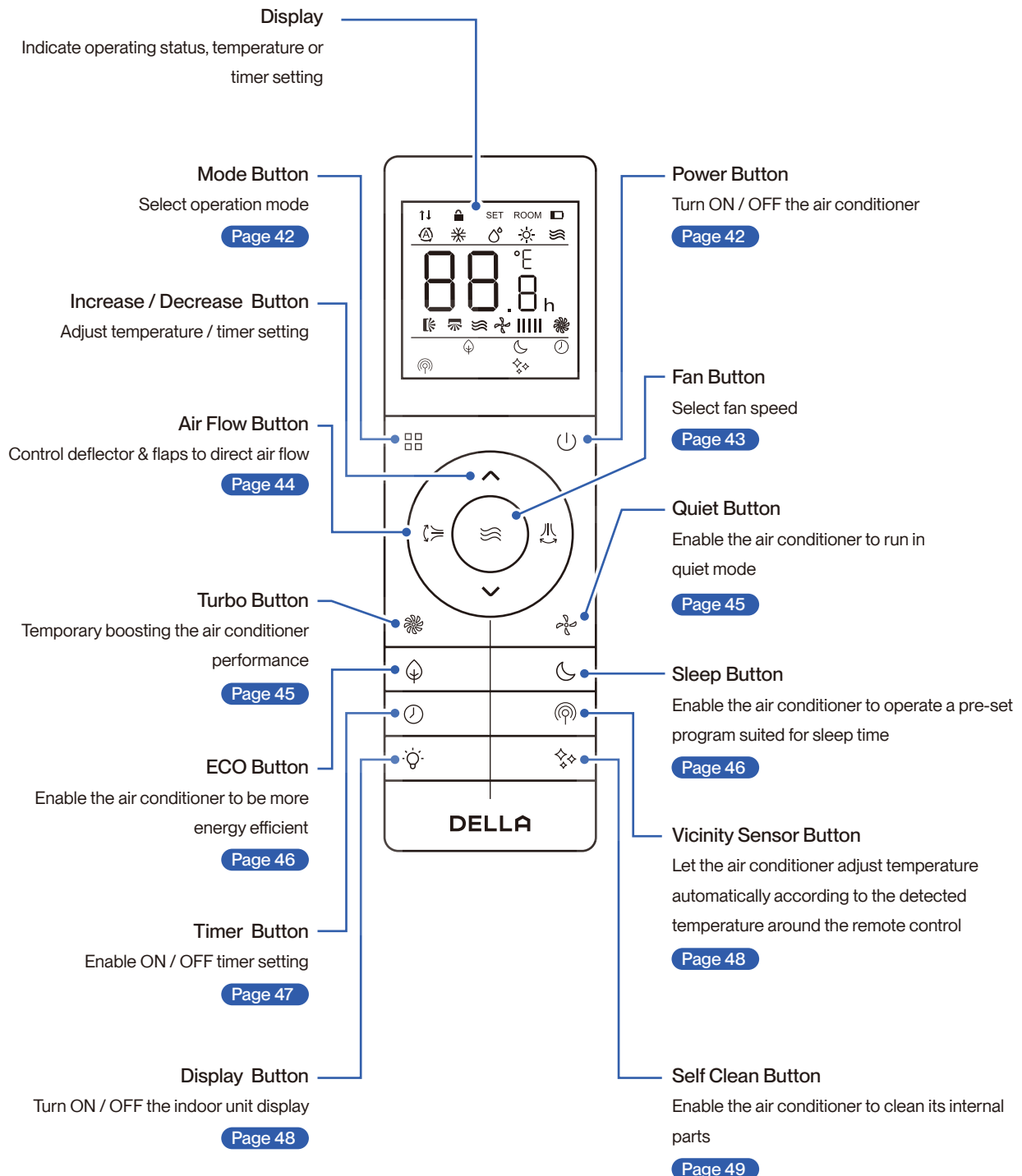

# Before Using

## Remote Control

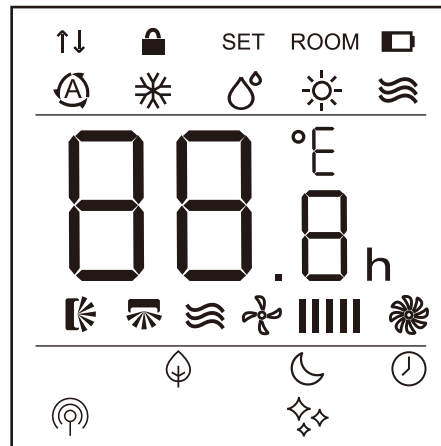

Before Using  
Before Using

LED Indicator	Function
	Signal Indicator
	Child Lock
SET	Indicate Set Temperature
ROOM	Indicate Room Temperature
	Low Battery
	Auto Mode
	Cool Mode
	Dehumidify Mode
	Heat Mode
	Fan Mode
88.8	Indicate Temperature Value
°F °C	Temperature Unit Degree Fahrenheit / Celsius

LED Indicator	Function
	Horizontal & Vertical Air Flow Indicator
	Quiet Mode
	Fan Speed
	Turbo Mode
	Eco Mode
	Sleep Mode
	Timer
	Vicinity Sensor Mode
	Self Clean

## Basic Operation

Basic Operation  
Basic Operation

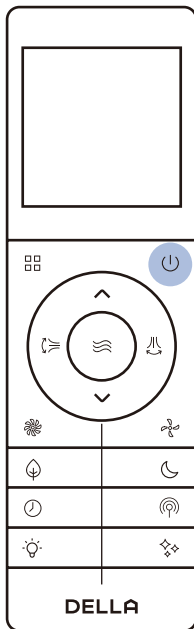

### Power ON

Press .

- The air conditioner will start operating.

### Power OFF

Press .

- The air conditioner will stop operating.

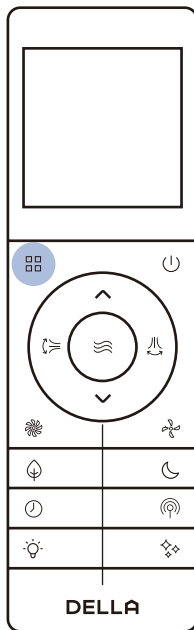



### Select Operation Mode

Press  to select operation mode.



- It may take a few minutes for the air conditioner to switch between modes.
- During Heat mode, the air conditioner can automatically activate defrost cycle, which is essential to remove frost on the condenser for heat exchange function. This procedure usually lasts for 2 - 10 minutes. When defrosting, indoor unit fan will stop operating. Once defrosting is completed, it will resume heat mode automatically.

### Auto mode operation

Set temp. is 3.6°F / 2°C < Room temp.	 Cool
Set temp. is 5.4°F / 3°C > Room temp.	 Heat
Set temp. = Room temp. ± 3.6°F / 2°C	 Fan / No Mode Change

- Auto mode allows the AC to automatically select operation mode based on the above logic.
- The AC compressor will stop for at least 20 mins before switching between cool and heat mode.
- Auto mode does not support turbo mode, sleep mode and eco mode operation.

# Basic Operation

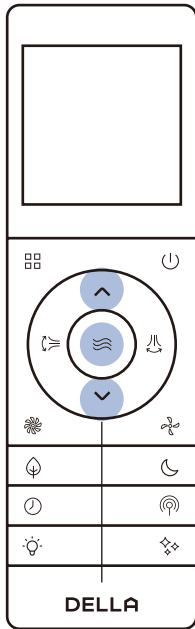

## Adjust Temperature

Press to adjust temperature setting .

- Temperature setting will adjust by 1°F / 1°C increment for each time the button is pressed.
- Press and hold the buttons to adjust temperature continuously.
- Temperature can only be set between 60°F - 90°F / 16°C - 32°C.

## Set Fan Speed

Press to select your desired fan speed.

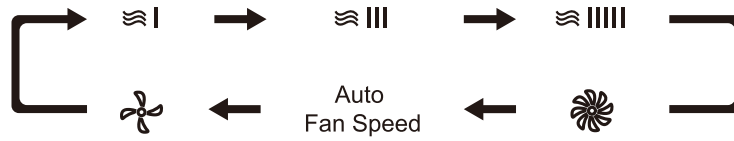

Basic Operation

	Auto	Cool	Dehumidify	Heat	Fan
Temperature Setting	60°F - 90°F / 16°C - 32°C				N/A
Fan Speed	All Fan Speed Except	All Fan Speed	Only	All Fan Speed	All Fan Speed Except Auto

## Basic Operation

Basic Operation  
Basic Operation

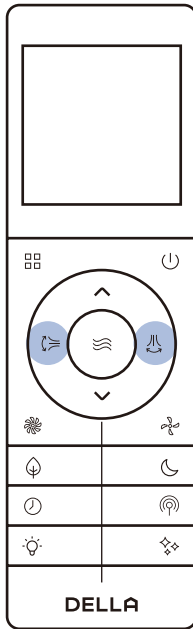

### Adjust Air Flow

Press  to oscillate horizontal flaps.

Press  one more time. → The flaps will stop at the position it was in when you pressed the button.

Press  to oscillate vertical vanes.

Press  one more time. → The vanes will stop at the position it was in when you pressed the button.

### QUICK TIPS

- When holding the horizontal flaps in place. It is recommended to hold the flaps in the up most position during cool mode. Vice versa, it is recommended to hold the flaps in the down most position during heat mode.



- Cold air tends to sink.

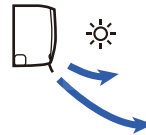

- Warm air tends to rise.

## Advance Function

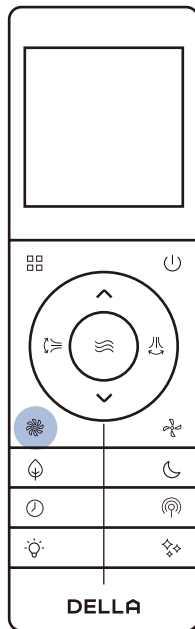





### Turbo Mode

Using turbo mode can boost the air conditioner performance in a short amount of time.

Press .

- The air conditioner will operate in boosted fan speed.
- Turbo mode is not available when the air conditioner is operating in dehumidification mode.

To stop turbo mode, press  again or press  /  / .

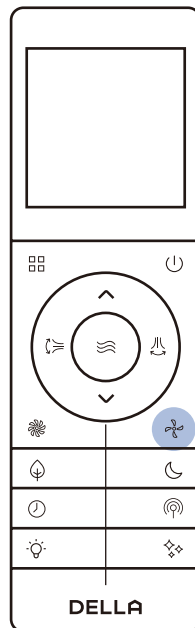





### Quiet Mode

The air conditioner will operate at the minimum noise level under quiet mode.

Press .

- The air conditioner will operate in the lowest fan speed.
- Quiet mode is not available when the air conditioner is operating in dehumidification mode.

To stop quiet mode, press  again or press  /  / .

## Advance Function

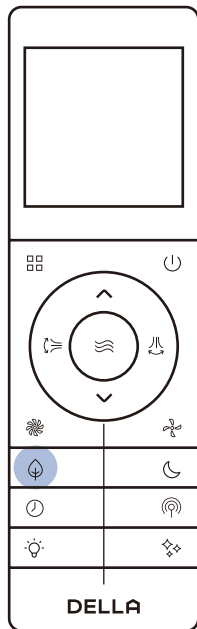

### ECO Mode

The air conditioner will operate with maximum energy efficiency.

Press  .

- ECO mode is only available when the air conditioner is operating in cool mode.

Press  again or turn off the AC to cancel ECO mode.

ECO mode will also automatically disabled after operating for 8 hours.

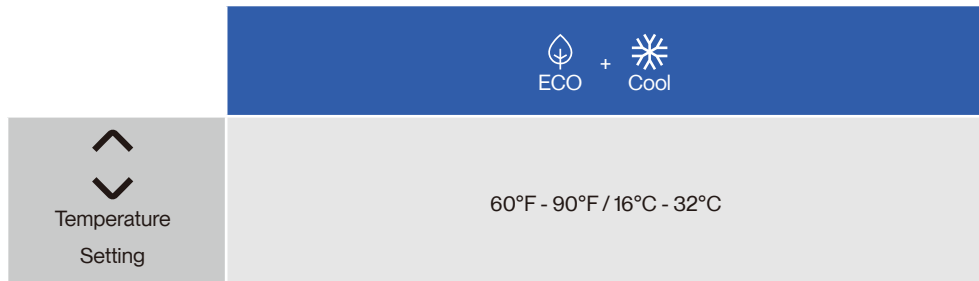

Advance Function  
Advance Function

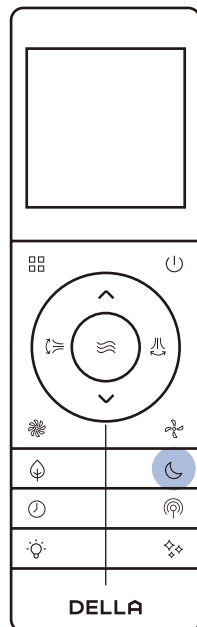

### Sleep Mode

In sleep mode, the air conditioner will operate a pre-set program which is suitable during sleep.

Press  .

- Sleep mode will operate for 10 hours and then switch back to previously set mode.
- Sleep mode is not available when the air conditioner is operating in fan mode.

Press  again to stop sleep mode.

# Advance Function

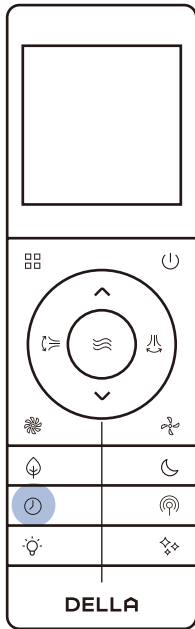

## Timer Function (Shutdown Timer)

Set a timer to automatically turn OFF the air conditioner.

- Press when the air conditioner is ON.
- Press to set the desired turn off time.
- Press to confirm the timer setting.

## Timer Function (Start-up Timer)

Set a timer to automatically turn ON the air conditioner.

- Press when the air conditioner is OFF.
- Press to set the desired turn on time.
- Press , , and to select your desired operation mode, temperature setting, and fan speed for when the air conditioner is turn ON.

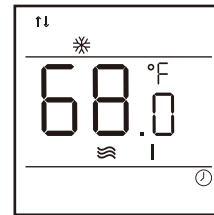
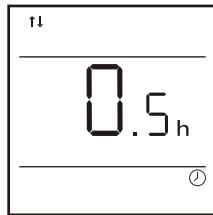

Press to confirm the timer setting.

### QUICK TIPS

- Both the shutdown and start-up timer can be set between 0.5 - 24 hours.

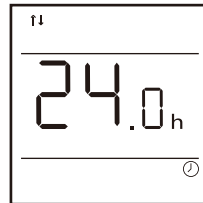
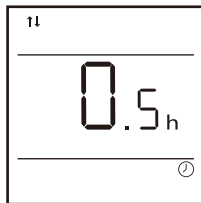

Timer default at 0.5 h

- While entering the setting, make sure to press the button within 10 seconds after the previous button was pressed. otherwise, the entire process will reset and you will have to start over.

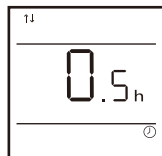

Timer Set

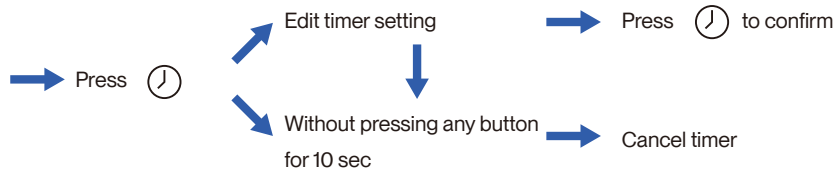

Advance Function  
Advance Function

## Advance Function

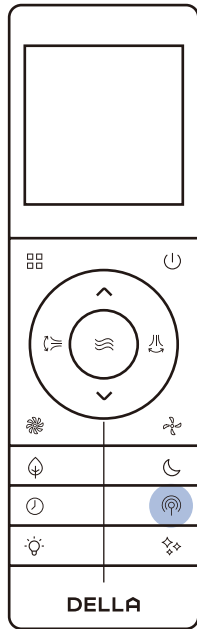

### Vicinity Sensor

Vicinity sensor function turns your remote control into a portable thermostat that automatically controls the unit to adjust the temperature of the room you are in.

Press  to activate vicinity sensor function.

- The display panel will show your set temperature.
- After setting your desire temperature, the display will flash for 5 seconds, and show the detected environment temperature.

Air conditioner would operate to match the detected temperature to the set temperature.

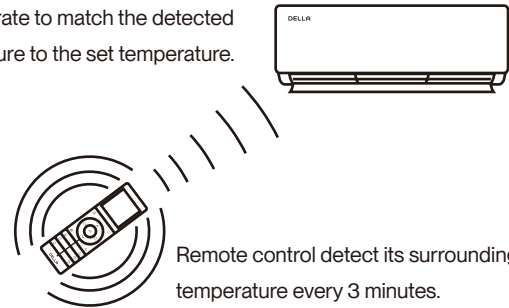

NOTE: The remote control must be pointed towards the indoor unit to prevent lost of communication.

- In the case of the temperature detected by the remote control is greater than 122 °F / 50 °C, or short circuit, the system will determine it as a malfunction / error on the remote control and automatically disable vicinity sensor function within 30 seconds.

Press  again to stop vicinity sensor function.

### Display ON / OFF

Switch ON / OFF the LED display on the indoor unit front panel.

Press  to turn OFF the indoor unit display.

- The display on the indoor unit will not lit up, and no indicator will be shown on the remote control.
- The AC will still function normally and commandable using the remote control.

Press  again to turn ON the indoor unit display.

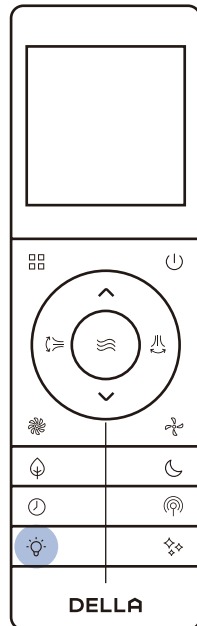

## Advance Function

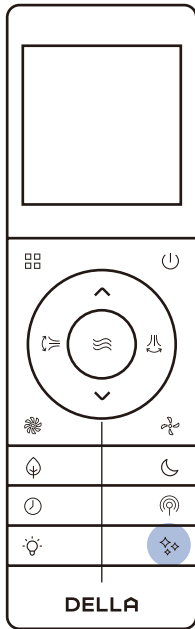

### Self Cleaning

Self cleaning function allows the air conditioner to clean the interior parts and helps carry away the accumulated dirt, bacteria, etc. from the indoor evaporator.

Press when the air conditioner is OFF.

- will display on the remote control display.
- will display on the indoor unit display.
- The self cleaning function will run for 30-50 minutes.
- If you enable self cleaning while the AC has a start-up timer set, The AC will start up once the self cleaning cycle is completed.
- It is recommended to operate this function when the indoor ambient temperature is under 86°F / 30°C, and the outdoor ambient temperature is between 41°F - 86°F / 5°C - 30°C.
- It is suggested to run the self cleaning function once every 3 months.
- It is normal that the unit makes some noise during self cleaning process as plastic materials expand and contract with temperature change.
- Press within 30 minutes of self cleaning function will terminate self cleaning.
- Turning ON the AC during self cleaning operation will terminate self cleaning and forced the AC into normal operation.

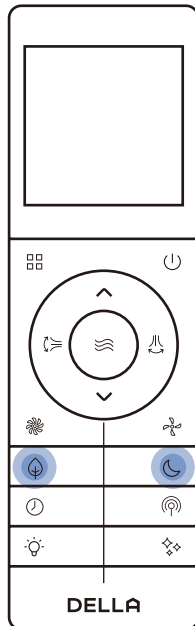

### Child Lock

Child lock function will disable all input from the remote control until unlocked.

Press and hold and for 3 seconds to activate child lock.

- will display on the remote control display.

Press and hold and for 3 seconds again to deactivate child lock.

## Advance Function

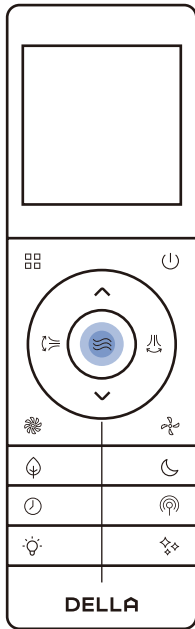

### °F / °C

Press and hold  for 5 seconds.

- The temperature unit will switch between °F and °C.

Advance Function  
Advance Function

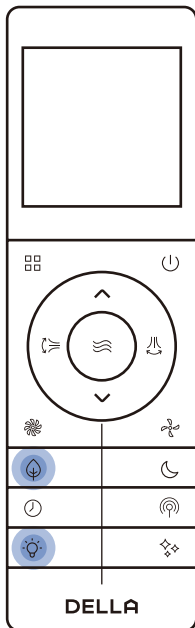

### Forced Defrost

To maximize heat efficiency, you can force the outdoor unit to perform a defrost cycle before using heat mode.

In heat mode, press and hold  and  for 10 seconds.

- The AC will make a "beep" sound and then enter defrost cycle.

Once the defrost cycle ends, the AC will automatically resume heat mode operation.

## Advance Function

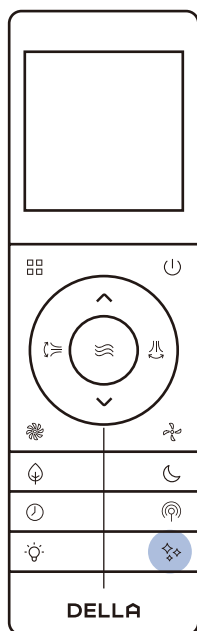

### Wi-Fi Reset

Wi-Fi reset function allows you to pair the air conditioner to your mobile device's app.

When the AC is on, press  8 times within 4 seconds.

- The indoor unit will make "beep beep" sound and reset the Wi-fi connection.
- More details on Wi-Fi set up on [Page 57](#)

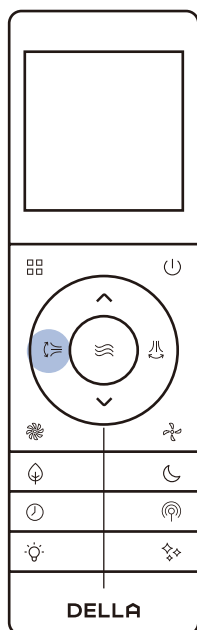

### Filter Cleaning Reset

Press  6 times within 3 seconds to enable filter cleaning reminder.

NOTE: Filter cleaning reminder is default off out of factory.

For every 500 hours of operation, the AC will remind you to clean the indoor air filter.

 will flash on the indoor unit display for 5 times when turning off the AC.

Press  6 times within 3 seconds to reset the filter cleaning reminder.

#### QUICK TIPS

- The self cleaning reminder will also automatically reset if it is ignored after turning OFF the AC for 5 times.
- It is recommended that the air filter is cleaned for the best performance.

# We work remotely, too.

The Della app combines smart technology with simple, user-friendly design, providing a seamless experience and endless customization. Automated smart features work behind the scenes to dial in your environment and improve your everyday, so you can focus on other, more interesting things.



## Advance Function

### Emergency Buttons

You can use the emergency buttons for limited control of the air conditioner in case the remote control fails or is missing.

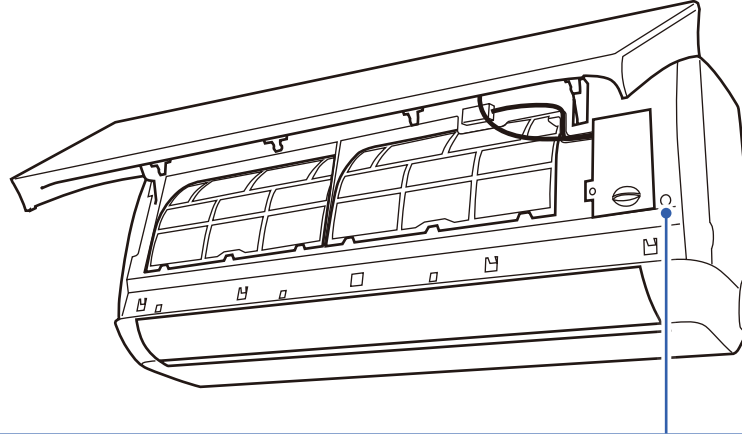

#### Indoor unit ON / OFF Switch

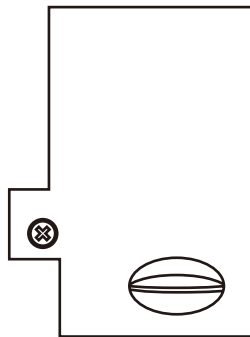

- When the unit is off, press this switch ONCE to start auto mode.
- In operation, press this switch ONCE to turn off the unit.



- Always wear insulation material when pressing the emergency buttons.

# Advance Function

## Wi-Fi Set up

To set up the DELLA+ app to control your AC.

1. Search "DELLA+" on Apple app store or Google Play, or scan the QR code below to download the application.
2. Register an account in the app.
3. Follow the in app instructions to add and pair your Della AC to the app and complete the Wi-Fi set up. You can also scan the device QR code in the DELLA+ app for a quick device search.

**DELLA+ App Download**



You can also scan the download QR code

**Device QR code**



Scan this QR code in your Della+ app to quickly add device.

## Household Set up (Optional)

Create and Join home to control your Della AC via the Della+ app from multiple devices and multiple accounts.

1. Click "Me" on the Della+ app.
2. Choose "Home Management".
3. Follow the in app instructions to create or join a home.

NOTE: Pairing your Della AC with a different account outside the household will remove the original pairing. Only one household can be paired at a time.

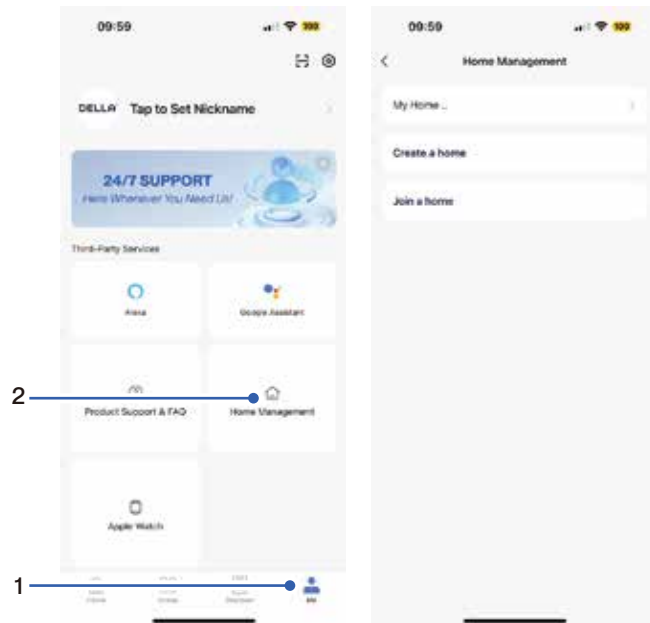

- The Della+ application is free, however, data charges may apply when downloading or using the application.
- Della+ can be altered without notice for quality improvement and also be deleted depending on the circumstances of manufacturing firms.
- All trademarks, logo, brand names are the property of their respective companies. Use of these names, brands, and trademarks does not imply endorsement. Della assumes no responsibility with regard to the performance or use of these products.



Check out detailed tutorial on the most updated application on [dellahome.com/support](http://dellahome.com/support).

## Care and Maintenance



- Before cleaning the unit, you must shut down the machine and cut off the power supply for at least 5 minutes.
- Never flush the air conditioner with water.

### Clean the Unit

1. Clean the air conditioner with a soft dry cloth or a dampened cloth with neutral detergent.
2. Remove any possible debris on the vents and air outlet.

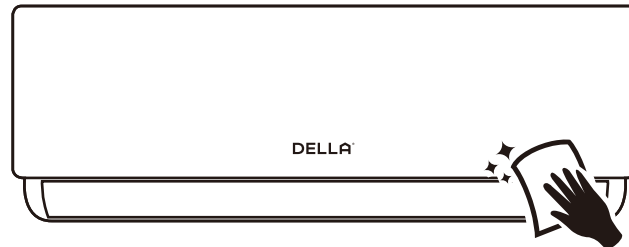

### Clean the Air Filter

1. Open the front panel.
2. Pull down the air filter.
3. Clean the air filter with soapy water.
4. Air dry the air filter.
5. Put the air filter back to its original position after it is dry.

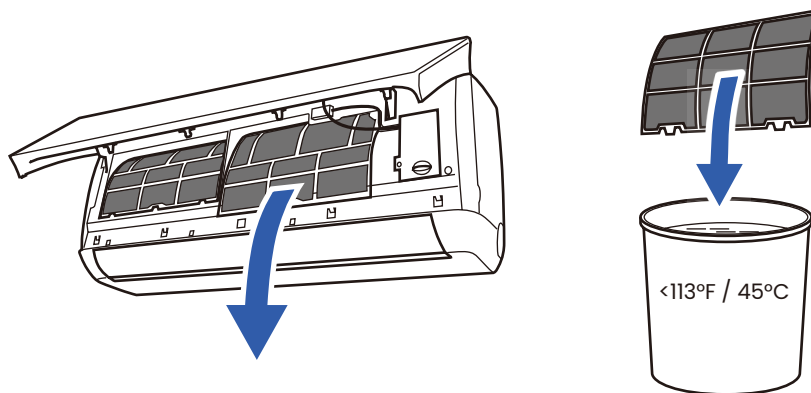

- Do not touch the fins inside the indoor unit with bare hands after removing the filter screen.
- Check and clean the air filter regularly to prevent dust accumulation.
- Clean the air filter frequently if the operating environment is dusty or has bad air quality.

# Care and Maintenance

## Maintenance Routine

- Clean the air filter screen every 3 months.
- Use the self clean function to clean the indoor unit every 3 months.
- [Page 51](#)
- Call your HVAC technician to check on the refrigerant level every 3 - 4 years.
- Regularly check and remove any obstacles from the outdoor unit.

## Planning to Not Operate the Air Conditioner for a Long Period

- Take out the batteries from the remote control and disconnect the power supply of the air conditioner.

## Using the Air Conditioner After a Long Idle Period

- Clean the unit and the air filter screen.
- Remove any obstacles at the air inlet and outlet of both the indoor and outdoor unit.
- Make sure drain pipe is unobstructed.
- Install batteries into the remote control and connect the power supply to the air conditioner.

## Troubleshooting

Before consulting repair or warranty, please check the following troubleshooting guide.

In the case of a persistent problem, contact a qualified technician for diagnosis and repair.



**WARNING**

- When encountering persisting problem, stop operation and turn off the breaker. Continue operation in an abnormal condition may cause electric shock, fire, or damage to the unit.
- Do not attempt to repair or modify the unit by yourself. Incorrect work may result in electric shock, fire or injury.

Problem	Possible Cause / Explanation / Solution
The appliance is non operational	When pressing the power button soon after operation was stopped - Protective delay switch will delay the operation for 3 - 5 minutes if the air conditioner is turned on immediately after it is turned off.
	When switching between operation modes - The internal protection is activated, wait for a few minutes for the AC to resume normal operation.
	The unit is currently has a turn ON timer activated.
	The circuit breaker is tripped. Reset the circuit breaker.
	Faulty electric connection, mismatch outlet voltage, or damaged electronic control board. Contact a qualified technician.
The appliance suddenly stopped during operation	An internal protection tripped after a sudden voltage fluctuation. Check the circuit breaker and reset if necessary.
	The environment temperature is too high or too low.
	The AC automatically activate de-frost process. This is not a malfunction.
	Air filter is too dirty. Clean the air filter.
	Some objects are obstructing air inlet or outlet of the indoor and / or the outdoor unit. Remove the obstructing object.
Strange odor from the air flow	Air filter is too dirty. Clean the air filter.
	The smells of the room, furniture, or cigarettes are absorbed into the unit and then discharged. Remove odorous objects from the room.
Strange Noise	In the case of water flowing noise - The noise may caused by the refrigerant flow, or the internal water flow during cold / dry mode. This is not a malfunction.
	In the case of plastic cracking noise - The noise may caused by the thermal expansion on plastic parts and does not indicate a problem..

Having Problems?  
Having Problems?

## Troubleshooting

Problem	Possible Cause / Explanation / Solution
Mist comes out from the air outlet	This occurs when the air in the room becomes cold in cool or dry mode. This does not indicate a problem.
No cool air in cold mode	When switching between operation modes - The internal protection is activated, wait for a few minutes for the AC to resume normal operation.
	Check and make sure the temperature setting is below the environment temperature.
No warm air in heat mode	When switching between operation modes - The internal protection is activated, wait for a few minutes for the AC to resume normal operation.
	Check and make sure the temperature setting is below the environment temperature.
	The AC automatically activate de-frost process. This is not a malfunction. Wait 2 - 10 minutes for the AC to complete defrosting.
	Frost built up on the outdoor unit. If the AC does not automatically activate de-frost process, force defrost process following instruction on page 49.
Insufficient air flow, either cold or hot	Some objects are obstructing air inlet or outlet of the indoor and / or the outdoor unit. Remove the obstructing object.
	Other heat source of heat in the room. Remove the heat source.
	The fan speed is set to minimum. Try to set at a higher fan speed.
The unit does not respond to the remote control commands	Remote Control is too far away from the indoor unit.
	There is an obstruction between the remote control and the indoor unit.
	The battery power has run out in the remote control. Replace the battery.
	Child lock function is activated. Deactivate child lock on the remote control.
The display on the indoor unit is not lit	The display is set to off on the remote control. Use the remote control to turn it on.
	Power failure. Check the power supply / circuit breaker.
Water dripping from the outdoor unit	The indoor unit internal is too dirty and clogged the drainage port. Contact qualified technician for cleaning.
	Condensation formed on the uninsulated drainage hose / refrigerant pipe in the line set. Contact qualified technician to properly insulate the water hose / refrigerant pipes.
	Improper drainage hose installation.

Having Problems?  
Having Problems?

## Troubleshooting



Switch off the air conditioner immediately and cut off the power supply in the event of:

- Strange, loud noises during operation.
- Faulty electronic control board.
- Faulty fuses or switches.
- Spraying water or objects inside the appliance.
- Frequent circuit breaker tripped during operation.
- Abnormally hot or damaged power cord or plug.
- Very strong smells discharging from the appliance.

### Error Code

Error Code	Description
E0	Indoor unit overcurrent protection
E1	Indoor unit temperature sensor error
E2	Outdoor unit coil sensor error
E3	Indoor unit coil sensor error
E4	Indoor unit fan error
E5 (5E)	Indoor and outdoor communication error
E8	Display board and main control panel communication error
F0	Outdoor unit fan error
F1	Module protection error
F2	Power Factor correction (PFC) board error
F3	Compressor out of step error
F4	Exhaust sensor error
F5	Compressor top head sensor error
F6	Outdoor unit temperature sensor error
F7	Overvoltage protection (OVP) or undervoltage protection (UVP) error
F8	Outdoor unit control panel and module panel communication error
F9	Outdoor EEPROM error

## Troubleshooting

Error Code	Description
FA	Recirculated sensor error
P2	High voltage switch protection
P3	Refrigerant deficiency protection
P4	Refrigerant overload protection
P5	Exhaust protection
P6	Indoor unit high temperature protection
P7	Anti freezing protection
P8	Overcurrent protection

Error codes shown on the air conditioner display panel only indicates communication problems between parts. For technicians attempt to identify the exact problematic parts or componants, visit our page on [dellahome.com/pages/umbra-troubleshooting](http://dellahome.com/pages/umbra-troubleshooting) for detailed model specific diagnostic handbook.



[dellahome.com/pages/umbra-troubleshooting](http://dellahome.com/pages/umbra-troubleshooting)

## Disposal Guideline

This appliance contains refrigerant and other potentially hazardous materials. When disposing of the appliance, follow all federal, state, and local regulations. DO NOT dispose of this product as normal household waste or unsorted municipal waste.

When disposing of this appliance, you have the following options:

- Dispose of the appliance at a designated municipal electronic waste collection facility.
- When buying a new appliance, the retailer will take the old appliance.
- The manufacturer may take back the old appliance.
- Sell the appliance to a certified scrap metal dealer.

Having Problems?  
Having Problems?

## Warranty



Scan the QR code or visit our page on [dellahome.com/pages/warranty](https://dellahome.com/pages/warranty) to sign up for warranty coverage on your new DELLA appliance.



[dellahome.com/pages/warranty](https://dellahome.com/pages/warranty)

## Compliance Information

### Radio Frequency Interference



Model: 048-MS-JPB series

ID: 2ANDL-TYAUX-J2

#### FCC Caution

This device complies with part 15 of the FCC Rules. Operation is subject to the following two conditions:

(1) This device may not cause harmful interference, and (2) this device must accept any interference received, including interference that may cause undesired operation. Any changes or modifications not expressly approved by the party responsible for compliance could void the user's authority to operate the equipment.

NOTE: This equipment has been tested and found to comply with the limits for a Class B digital device, pursuant to Part 15 of the FCC Rules.

These limits are designed to provide reasonable protection against harmful interference in a residential installation. This equipment generates, uses and can radiate radio frequency energy and if not installed and used in accordance with the instructions, may cause harmful interference to radio communications. However, there is no guarantee that interference will not occur in a particular installation. If this equipment does cause harmful interference to radio or television reception, which can be determined by turning the equipment off and on, the user is encouraged to try to correct the interference by one or more of the following measures:

- Reorient or relocate the receiving antenna.
- Increase the separation between the equipment and receiver.
- Connect the equipment into an outlet on a circuit different from that to which the receiver is connected.
- Consult the dealer or an experienced radio / TV technician for help.

## Memo







🌐 [www.dellahome.com](http://www.dellahome.com)

✉ [support@dellahome.com](mailto:support@dellahome.com)

📞 800-863-4143

🕒 6:00 a.m. – 4:00 p.m. PST Monday – Friday

© Della All rights reserved.

The design and specifications are subject to change without prior notice for product improvement. Any updates to the manual will be uploaded to the della website.

---