

DELLA®

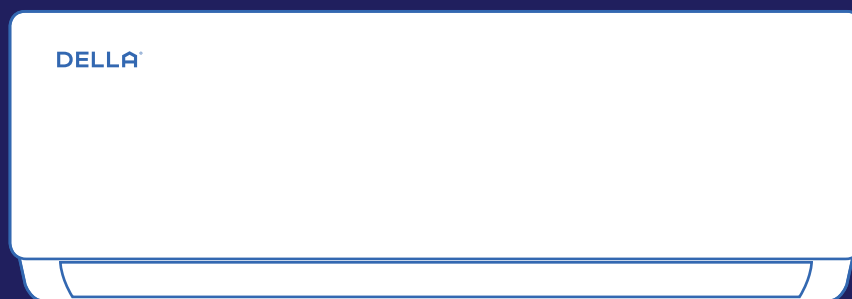

Versa (TL) Series

Instruction Manual
Installation and Operation Guide



Welcome to **DELLA**[®]

5 Things to know before installation

Thank You for trusting Della as your home comfort solution. We know no better how exciting it must be to have a new and functional AC to make your living space more comfortable. But AC installation, in reality, is far from being simple. Here are a few things you must know before installing the AC whether by yourself or by a professional HVAC technician. This will give you an idea of what to look out for installing an AC so that it can perform at its maximum efficiency and every dollar you invest in it pays off.



The installation location is critical

Not all places are created equal. Only proper placement of the AC will maximize efficiency while balancing the interior aesthetic. As wall requires for the installation, you need to make sure to get the placement and location right the first time.

Page 14



Handle the refrigerant pipes perfectly

The refrigerant pipe is one of the most important, if not the most important, parts of the mini split AC system. You might need special-purpose tools to shorten and bend the pipe or purchase lengthening pipes to match your connection length. Additional refrigerant might also needed, depending on your installation. Any flaw in the handling of the refrigerant pipes may cause a refrigerant leak or reduced efficiency. The cost of replacement and re-installation of the refrigerant pipe can quickly upset any DIYer trying to save from hiring a professional.

Contact us if you need extra refrigerant.

Page 22



Bundle the line set correctly

The line set contains the refrigerant pipes, drain hose, and electrical wires. A good bundling prevent water condensation and protects it from external elements, as well as matching the exact distance of the installation. No one wants extra line set dangling around.

Page 18, 34



Vacuum pumping the refrigerant circuit

Mini-split AC absolutely needs vacuum pumping in order to perform efficiently and prevent refrigerant from reacting with air moisture and damaging the internal parts of the machine. With a vacuum pump and a micron gauge, the process does not take very long, but it is important to do it right.

Page 28



Safe electrical connection

A safe and properly electrical connection is crucial necessity for the installation. The voltage, power breaker protection, and wiring must correspond to the specifications of each model. A poor connection can quickly becomes a fire hazard.

Page 12, 25



Most of the problems emerge from incorrect or poor installation. Installation performed by professional HVAC technician can greatly reduce the chance of having problems for years to come. On top of that, Della provide extended warranty for professional installation. If you need assistance or have questions, we are here for you.



support.dellahome.com/en-US



800-863-4143
6:00 a.m. - 4:00 p.m. PST
Monday - Friday



24/7 Live Chat

Table of Content

Before Installation

Warning and Safety	04
Name of Parts	07
Product Specification	09

Installation

Installation Preview	11
Installation Info	12
Indoor Unit Installation	15
Outdoor Unit Installation	20
Circuit Diagram	26
Finishing Touch	34
Check List	35
Test Run	36

Before Using

Operation Tips	37
Front Panel	38
Remote Control	39

Basic Operation

Power ON / OFF	44
Operation Modes	44
- Auto, Cool, Heat, Dry, Fan	44
Change Temperature	45
Change Fan Speed	45
Adjust Airflow	46

Advance Function

Turbo Mode	47
Quiet Mode	47
Eco Mode	48
Sleep Mode	48
Timer	49
Vicinity Sensor	50
Display ON / OFF	50
Self Cleaning	51
Child Lock	51
°F / °C	52
Force Defrost	52
Wi-Fi Reset Button	53
Emergency Button	53
Wi-Fi Setup	56

Care and Maintenance

Air Filter	57
Maintenance Routine	58

Having Problems?

Troubleshooting	59
Disposal Guideline	62
Warranty	63

Warning and Safety

- Read this guide before installation. Failure to follow the safety instructions may result in property damage, serious injury, or death.
- Please Keep this manual.



Danger:

Indicates an IMMEDIATELY hazardous situation that, if not avoided, will result in death, serious injury, or serious property damage.



Warning:

Indicates an POTENTIALLY hazardous situation that, if not avoided, will result in death, serious injury, or serious property damage.



Caution:

Indicates an POTENTIALLY hazardous situation that, if not avoided, will result in minor to moderate injury. It may also be used to indicate unsafe practice.



Attention:

Pay additional attention to the instruction.



DO NOT:

Indicates prohibited actions and / or practice.

About Refrigerant



- The air conditioner is pre-charged with refrigerant. Handle the air conditioner with care and check if there is any refrigerant leakage during installation. Refrigerants have no odor and can be toxic and flammable. Rapid evaporation of refrigerant may cause frostbite, cardiac arrhythmia, and / or irritation, as well as cause environmental damage.



- In the case of refrigerant leakage, shut down the appliance and disconnect from the power supply. An inspection must be performed by a qualified technician.

About Installation









- The room for the installation, use, repair, and / or storage of this air conditioner should be greater than 54 sq ft / 5m².
- Stop valve cover must be installed on the air conditioner to prevent possible refrigerant leak.
- Refrigerant leakage or damaged pipelines must be inspected and repaired by a qualified HVAC technician.





- The appliance must be installed in accordance with applicable federal, state, and local regulations.



Warning and Safety



About Installation	
 WARNING 	<ul style="list-style-type: none"> Do not install or store this appliance in a room with continuously operating ignition sources such as open flames, gas appliances, or electric heater. Do not install the appliance within 20" / 50cm of flammable substances such as alcohol, etc. Or pressurized containers such as spray cans. Do not alter, change, or modify the appliance.
 CAUTION	<ul style="list-style-type: none"> Prevent children from accessing the work area during installation to prevent unforeseeable accident. The base of the outdoor unit must be firmly fixed. Carry out a test run after the installation. Installation of a mini split AC requires specialized training and equipment. Hire a licensed professional if not familiar with electrical wiring and HVAC system. The packaging materials are recyclable and should be disposed of in a separate waste bins. The appliance should not be installed in a location where the air outlet of the indoor or outdoor unit is obstructed. Obstruction of these opening may cause damage or malfunctions to the appliance.

About Power and Electricity	
 WARNING 	<ul style="list-style-type: none"> Ensure that the power voltage corresponds to that stamped on the rating plate. A fuse or overload protection device with a suitable capacity for indoor unit must be installed. The appliance must be fitted with means for disconnection from the main power supply under over-voltage category III conditions. All electrical wiring must follow federal, state, or local regulations. When working on the electric terminals, ensure the appliance is disconnected from the power supply. Make sure the appliance is properly grounded to prevent electric shock.
 WARNING 	<ul style="list-style-type: none"> Do not bend, tug, or compress the power cord during installation to prevent damaging the power cord. Damaged electrical cord should be replaced by a qualified electrician. Do not use power extensions and / or multi-socket modules for appliance installation.

Warning and Safety

About Operation	
 WARNING 	<ul style="list-style-type: none"> Do not disconnect the appliance from the power supply before shutting off the appliance. This might create a spark and potentially cause a fire. Do not place flammable substances near the appliance. Do not climb onto or place any objects on the appliance. Do not insert any objects into the appliance to prevent damage or injury. Do not obstruct the air inlet or outlet. Do not operate the appliance with wet hands.
 CAUTION	<ul style="list-style-type: none"> If the appliance is used in areas without the possibility of ventilation, precautions must be taken to prevent any leaks of refrigerant. Only use the appliance as instructed in this booklet. These instructions are not intended to cover every possible condition and situation. As with any electrical household appliance, common sense and caution are therefore always recommended for usage and maintenance. This appliance is designed and made for air conditioning in domestic environments only. It must not be used for any other purpose such as drying clothes or cooling foods. This appliance can be used by children 8 years old or above and persons with reduced physical, sensory, or mental capabilities, or lack of experience and knowledge if they have been given supervision or instruction concerning the use of the appliance in a safe way and understand the hazards involved. Children shall not play with the appliance.

Encountering Troubles	
 WARNING 	<ul style="list-style-type: none"> In the case of the appliance emitting smoke, burning smell, leaking water, or making unusual noise, shut down the appliance and disconnect from the power supply immediately. Contact a qualified technician for inspection and repair.

About Handling and Maintenance	
 WARNING 	<ul style="list-style-type: none"> Do not attempt to disassemble, alter, or modify the appliance. Do not flush the air conditioner with water. Do not attempt to repair, relocate, modify or reinstall the air conditioner by yourself. Incorrect work could cause electric shocks, fire or damage. Contact a qualified technician.
 WARNING	<ul style="list-style-type: none"> Before cleaning the unit, the appliance must be shut down and disconnect from the power supply for at least 5 minutes.

Name of Parts

Indoor Unit

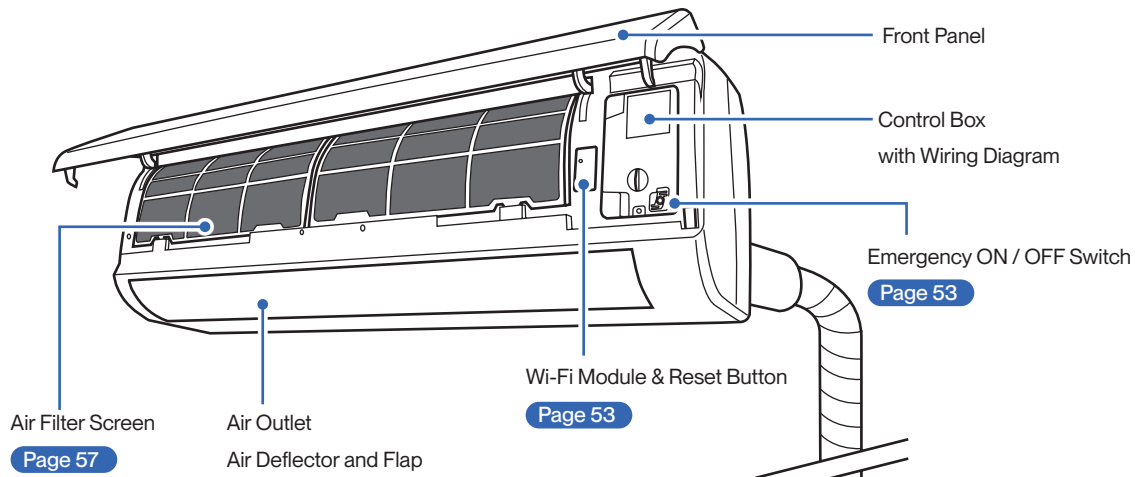

Outdoor Unit

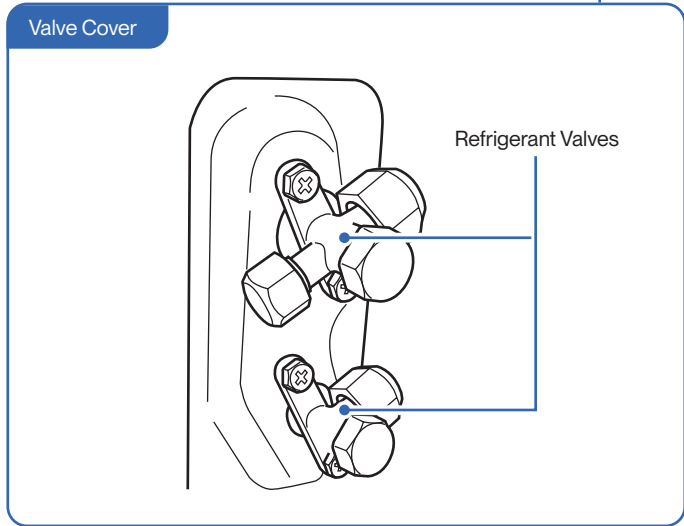
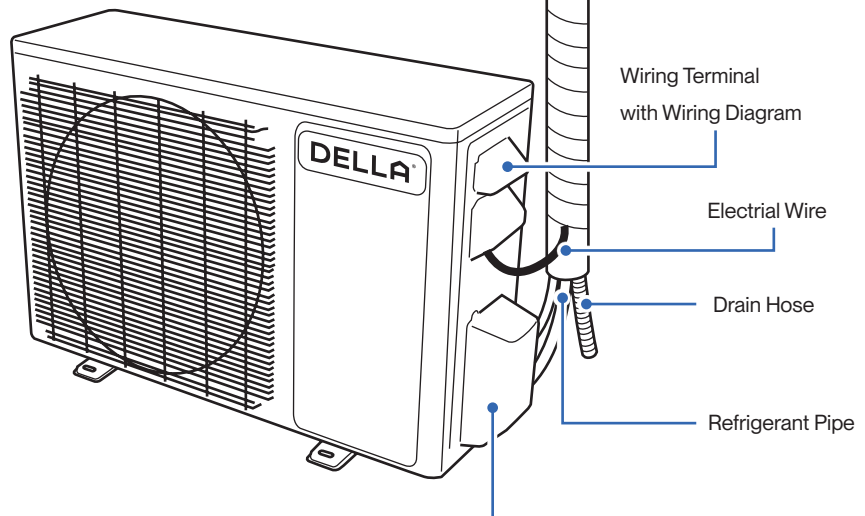

Before Installation
Before Installation

Name of Parts

Included Accessories

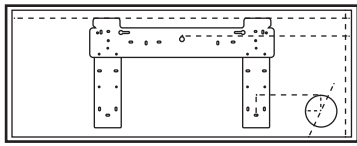

Bracket Template

1x

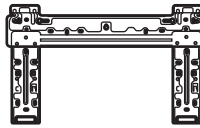

Mounting Plate

1x



Electrical Wire Set

1x

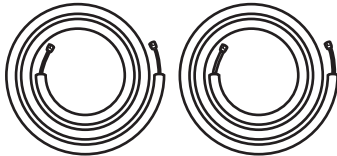

Refrigerant Pipe

Narrow 1x

Thick 1x

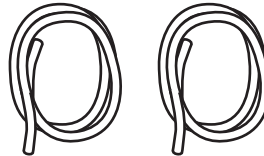

Drain Hose

2x

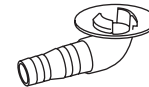

Drainage Joint

1x

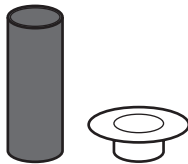

Wall Sleeve & Cover

1x

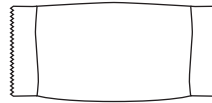

Plasticine Putty

1x

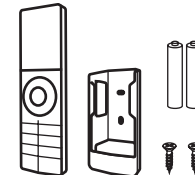

Remote Control, Holder 1x

Battery 2x

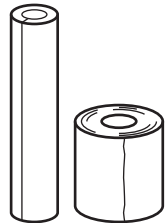

Insulation Foam & Wrap

1x



Rubber Foot Pad

4x

Tools Needed (Not included)

- Screw Driver
- Hole Saw Ø2.75" / Ø70mm
- Refrigerant Leak Detector / Liquid Leak Detector
- Allen Wrench
- Spanner
- Torque Wrench
- Measuring Tape
- Spirit Level
- Stud Finder
- Thermometer
- Vacuum Pump
- Dry Wall Anchors / Molly Bolts
- Wood Screws
- Floor Mounting Base Kit / Wall Mount Kit
- Micron Gauge / AC manifold Gauge
- Copper Pipe Bender
- Caulk
- Tubing Cutter*
- Pipe Reamer*
- Tubing Flaring Tool*
- Wire cutter*

NOTE: Tools marked with * are needed for shortening the refrigerant pipe and / or electrical wire to the exact desired length.

ONLY a qualified HVAC technician should attempt altering the pipe length and / or the wire length.

Product Specification

	048-TL-9K1V-19S	048-TL-9K2V-19S	048-TL-12K1V-19S	048-TL-12K2V-19S
Power Supply	115 V / 60 Hz / 1P	208 V - 230 V / 60 Hz / 1P	115 V / 60 Hz / 1P	208 V - 230 V / 60 Hz / 1P
Rated Cooling Capacity (Btu / h)	9000	9000	12000	12000
Rated Heating Capacity (Btu / h)	10000	10000	12200	12200
Cooling	Power Consumption	840 W	1130 W	1140 W
	Rated Current	7.4 A	10.2 A	5.1 A
Heating	Power Consumption	810 W	1090 W	1050 W
	Rated Current	7.2 A	9.6 A	5.1 A
Noise Level	Indoor Unit	26 - 41 dBA	27 - 42 dBA	27 - 42 dBA
	Outdoor Unit	51 dBA	50 dBA	52 dBA
Dimension	Indoor Unit	31.92" x 11.49" x 8.07" 811 mm x 292 mm x 205 mm	31.92" x 11.49" x 8.07" 811 mm x 292 mm x 205 mm	31.92" x 11.49" x 8.07" 811 mm x 292 mm x 205 mm
	Outdoor Unit	28.14" x 11.42" x 19.61" 715 mm x 299 mm x 498 mm	28.14" x 11.42" x 19.61" 715 mm x 299 mm x 498 mm	28.14" x 11.42" x 19.61" 715 mm x 299 mm x 498 mm
Net Weight	Indoor Unit	19.8 lb / 9 kg	19.8 lb / 9 kg	19.8 lb / 9 kg
	Outdoor Unit	48.5 lb / 22 kg	65 lb / 29.5 kg	57.3 lb / 26 kg
Suitable Area	Up to 400 sq. ft	Up to 400 sq. ft	Up to 550 sq. ft	Up to 550 sq. ft
Moisture Removal (per hour)	2.3 pints / 1.1 L	2.3 pints / 1.1 L	3.4 pints / 1.6 L	3.4 pints / 1.6 L
Refrigerant	R410A	R410A	R410A	R410A

Before Installation
Before Installation

Product Specification

Before Installation
Before Installation

	048-TL-18K2V-19S	048-TL-24K2V-19S	048-TL-36K2V-19S
Power Supply	208 V - 230 V / 60 Hz / 1P	208 V - 230 V / 60 Hz / 1P	208 V - 230 V / 60 Hz / 1P
Rated Cooling Capacity (Btu / h)	18000	24000	36000
Rated Heating Capacity (Btu / h)	19600	24400	36000
Cooling	Power Consumption	2360 W	3850 W
	Rated Current	11.0 A	16.5 A
Heating	Power Consumption	2230 W	3500 W
	Rated Current	7.7 A	15.2 A
Noise Level	Indoor Unit	35 - 51 dBA	36 - 52 dBA
	Outdoor Unit	54 dBA	63 dBA
Dimension	Indoor Unit	46.93" x 14.17" x 10.23" 1192 mm x 360 mm x 260 mm	46.93" x 14.17" x 10.23" 1192 mm x 360 mm x 260 mm
	Outdoor Unit	39.76" x 12.40" x 8.66" 1010 mm x 315 mm x 220 mm 30.70" x 13.74" x 23.81" 780 mm x 349 mm x 605 mm	33.26" x 14.96" x 27.51" 845 mm x 380 mm x 699 mm
Net Weight	Indoor Unit	28.7 lb / 13 kg	39.7 lb / 18 kg
	Outdoor Unit	70.6 lb / 32 kg	114.6 lb / 52 kg
Suitable Area	Up to 1000 sq. ft	Up to 1500 sq. ft	Up to 2500 sq. ft
Moisture Removal	4.6 pints / 2.2 L	5.5 pints / 2.6 L	6.3 pints / 3 L
Refrigerant	R410A	R410A	R410A

Installation Preview

- 1 Choose the installation location
Page 14
- 2 Drill wall hole and
Install mounting plate
Page 15-16
- 3 Indoor unit connection
 - Connect the drain hose to the indoor unit
Page 17
 - Pass the electrical wire into the indoor unit
Page 18
- 4 Mount the indoor unit
Page 19

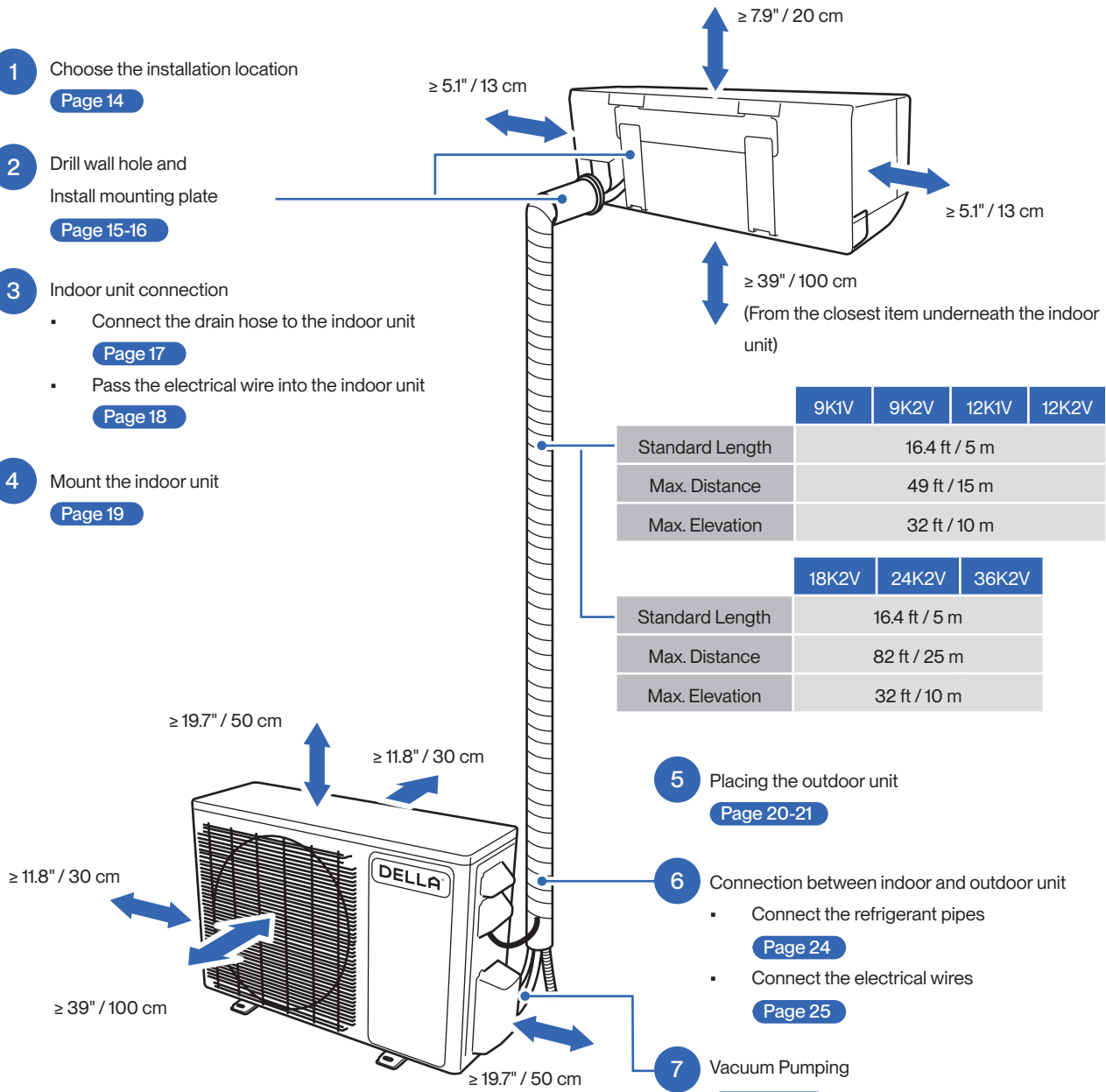

- 5 Placing the outdoor unit
Page 20-21
- 6 Connection between indoor and outdoor unit
 - Connect the refrigerant pipes
Page 24
 - Connect the electrical wires
Page 25
- 7 Vacuum Pumping
Page 30-33
- 8 Finishing
Page 34
- 9 Check List
Page 35
- 10 Test Run
Page 36

Installation Info (Power Supply and Breaker Size)

Installation
Installation

Power Supply and Breaker Size

	048-TL-9K1V-19S	048-TL-9K2V-19S	048-TL-12K1V-19S	048-TL-12K2V-19S
Power Supply	115 V / 60 Hz / 1P	208 V - 230 V / 60 Hz / 1P	115 V / 60 Hz / 1P	208 V - 230 V / 60 Hz / 1P
Cooling	Power Consumption	840 W	1130 W	1140 W
	Rated Current	7.4 A	3.7 A	5.1 A
Heating	Power Consumption	810 W	770 W	1050 W
	Rated Current	7.2 A	3.4 A	5.1 A
Min. Circuit Ampacity	17 A	15 A	17 A	11 A
Min. Wire Size (American Wire Gauge)	16 AWG	16 AWG	16 AWG	16 AWG
Breaker Size	25 A	15 A	25 A	15 A

	048-TL-18K2V-19S	048-TL-24K2V-19S	048-TL-36K2V-19S	
Power Supply	208 V - 230 V / 60 Hz / 1P	208 V - 230 V / 60 Hz / 1P	208 V - 230 V / 60 Hz / 1P	
Cooling	Power Consumption	1840 W	2360 W	3850 W
	Rated Current	8.2 A	11.0 A	16.5 A
Heating	Power Consumption	1730 W	2230 W	3500 W
	Rated Current	7.7 A	10.5 A	15.2 A
Min. Circuit Ampacity	13 A	19 A	23 A	
Min. Wire Size (American Wire Gauge)	16 AWG	16 AWG	16 AWG	
Breaker Size	20 A	30 A	35 A	

Installation Info (Refrigerant and Pipe Set Info)

Refrigerant and Pipe Set Info

	048-TL-9K1V-19S	048-TL-9K2V-19S	048-TL-12K1V-19S	048-TL-12K2V-19S
Stand Length	16.4 ft / 5 m	16.4 ft / 5 m	16.4 ft / 5 m	16.4 ft / 5 m
Max. Distance Between Indoor and Outdoor Unit	49 ft / 15 m	49 ft / 15 m	49 ft / 15 m	49 ft / 15 m
Max. Elevation Between Indoor and Outdoor Unit	32 ft / 10 m	32 ft / 10 m	32 ft / 10 m	32 ft / 10 m
Type of Refrigerant	R410A	R410A	R410A	R410A
Additional Refrigerant Charge	0.2 oz / ft (20 g / m)	0.2 oz / ft (20 g / m)	0.2 oz / ft (20 g / m)	0.2 oz / ft (20 g / m)
Liquid Line	1/4"	1/4"	1/4"	1/4"
Torque Parameter	18 - 20 N-M / 13.3 - 14.8 lbf-ft / 1.8 - 2.0 kgf-m	18 - 20 N-M / 13.3 - 14.8 lbf-ft / 1.8 - 2.0 kgf-m	18 - 20 N-M / 13.3 - 14.8 lbf-ft / 1.8 - 2.0 kgf-m	18 - 20 N-M / 13.3 - 14.8 lbf-ft / 1.8 - 2.0 kgf-m
Pipe Diameter	3/8"	3/8"	3/8"	3/8"
Gas Line	3.0 - 3.6 kgf-m	3.0 - 3.6 kgf-m	3.0 - 3.6 kgf-m	3.0 - 3.6 kgf-m
	048-TL-18K2V-19S	048-TL-24K2V-19S	048-TL-36K2V-19S	
Stand Length	16.4 ft / 5 m	16.4 ft / 5 m	16.4 ft / 5 m	
Max. Distance Between Indoor and Outdoor Unit	82 ft / 25 m	82 ft / 25 m	82 ft / 25 m	
Max. Elevation Between Indoor and Outdoor Unit	32 ft / 10 m	32 ft / 10 m	32 ft / 10 m	
Type of Refrigerant	R410A	R410A	R410A	
Additional Refrigerant Charge	0.32 oz / ft (30 g / m)	0.32 oz / ft (30 g / m)	0.32 oz / ft (30 g / m)	
Liquid Line	1/4"	1/4"	1/4"	
Torque Parameter	18 - 20 N-M / 13.3 - 14.8 lbf-ft / 1.8 - 2.0 kgf-m	18 - 20 N-M / 13.3 - 14.8 lbf-ft / 1.8 - 2.0 kgf-m	18 - 20 N-M / 13.3 - 14.8 lbf-ft / 1.8 - 2.0 kgf-m	
Pipe Diameter	3/8"	1/2"	5/8"	
Gas Line	3.0 - 3.6 kgf-m	4.6 - 5.1 kgf-m	6.1 - 6.6 kgf-m	

Installation Info

Picking a Installation Location for the Indoor Unit

- Ensure the installation complies with the minimum clearance space surrounding the unit and is within the maximum piping length and maximum elevation defined in the installation information.

Page 13

- Make sure the wall is strong enough to hold the weight of the indoor unit and prevent it from vibration.
- Make sure the air inlet and outlet are clear of any obstruction.
- Make sure condensation can be easily drained.
- A place where all connections can be easily made to the outdoor unit.
- A place where the indoor unit is out of children's reach.
- A place where the indoor unit is accessible for maintenance.
- Install the indoor unit 10 ft / 3 m away from TV or radio appliances.

NOTE: Radio interference may occur if appliances are placed too close to each other.

- Do not install in a laundry room or by a swimming pool.
- There should not be any heat source near the indoor unit.
- Do not install the indoor unit near the door way.

⚠ To prevent the indoor unit from falling down and blocking exit way in case of an emergency such as fire or earthquake etc.

Picking a Installation Location for the Outdoor Unit

- Do not install the outdoor unit near a heat source, steam, or flammable gas.
- Do not install the outdoor unit in windy or dusty locations.
- Do not install the outdoor unit in places where people often pass.
- Avoid installing the outdoor unit in places where it will be exposed to direct sunlight.

NOTE: If necessary, build a protection that does not interfere with the airflow.

- Make sure there is enough space around the outdoor unit to circulate air.

Page 11

- Outdoor unit must be placed in a safe and solid location.
- The outdoor unit should ideally be placed on a elevated concrete pad.
- If installing in snowy region, it is recommended the outdoor unit to be installed above the seasonal snow level.

Indoor Unit Installation

Install the Mounting Bracket

1. Locate the studs and electrical wires inside the wall. Then use the template included with the indoor unit or the etched marking on the mounting plate to determine the exact mounting location.
2. Use a spirit level to level the mounting plate on the wall. Then mark out the screw hole positions.
3. Insert wall anchors into the holes and affix the mounting plate to the wall using screws.
Use a wood screw if the hole position is directly on a wood stud.

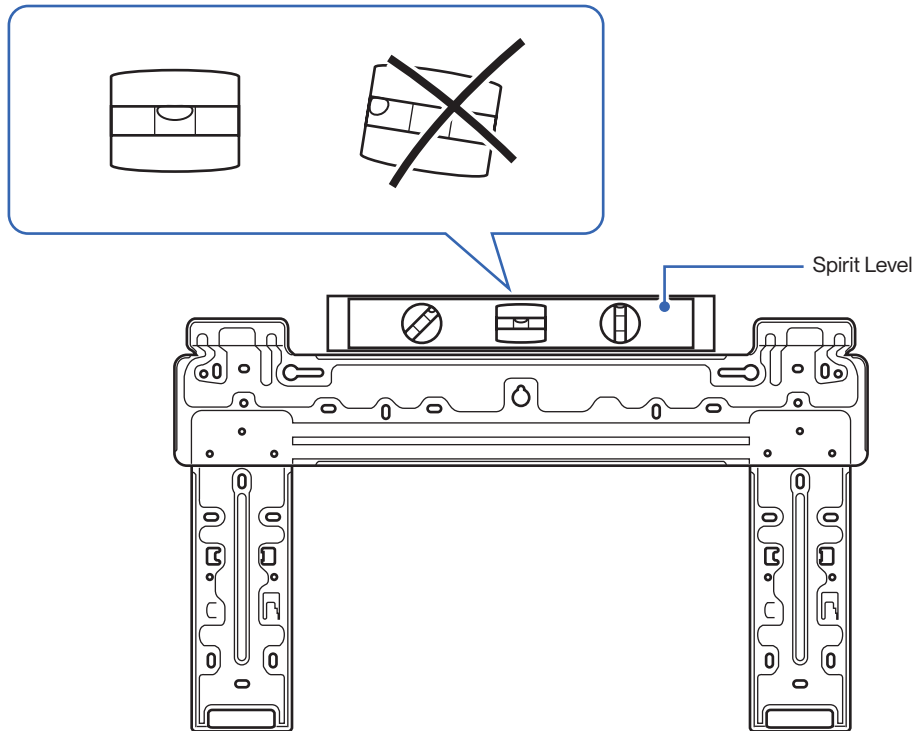

Hollow Drywall

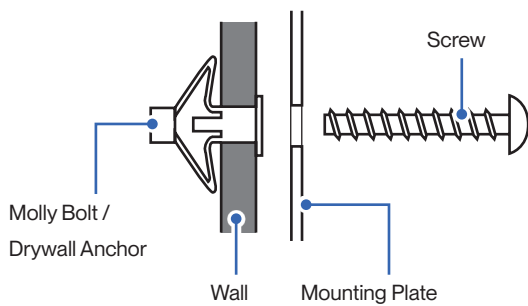

Wood Stud

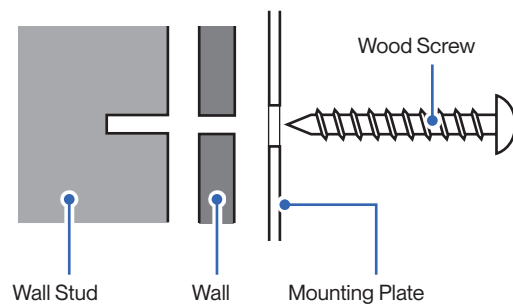

- You must use the correct wall anchor according to the type of the wall.

Indoor Unit Installation

Drill Wall Hole and Insert Wall Sleeve

- Pick 1 of the 3 piping positions on your indoor unit.

Piping Position

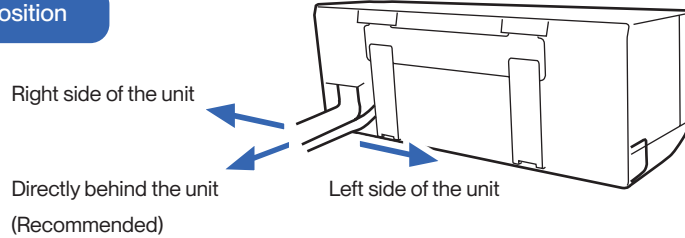

- Mark the position on the wall.

Example of Wall Hole Position with Piping Directly Behind the Indoor Unit

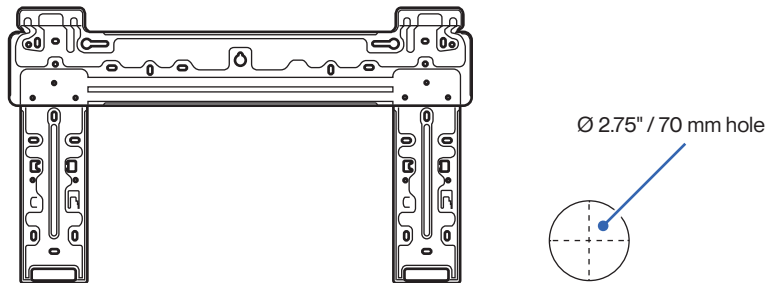

WARNING

- Make sure there is no building structure pillar, stud, electrical wire, or any water pipes in the way of the drill hole. Drilling into electrical wires or water pipes inside the wall may cause electric shock, fire, or water damage.

- Drill a 2.75" / 70 mm hole from the indoor wall to the outdoor wall. The hole must be slanted downward with a small angle.
- Insert the wall sleeve and sleeve cover into the wall. Then seal off gaps with putty or caulk.

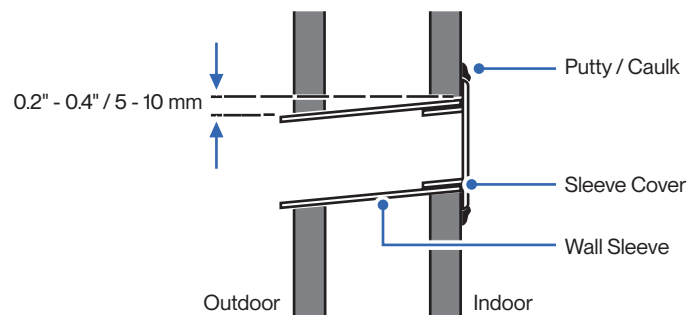

- Always insert the sleeve into the wall hole and seal the surrounding with putty / caulk. This will prevent water, insects, or small animals from getting into the house.

Indoor Unit Installation

Connect the Indoor Unit Drain Hose

1. Connect the drainage hose to the indoor unit drainage port.

NOTE: In some models, drainage ports are available on both sides of the indoor unit. You can choose one side to attach the drain hose and insert a rubber plug on the unused port. Always pick the side closer to the wall hole.

2. Make sure the joint is firmly connected and has a good seal.
3. Wrap the joint with Teflon tape to prevent any possible leak.

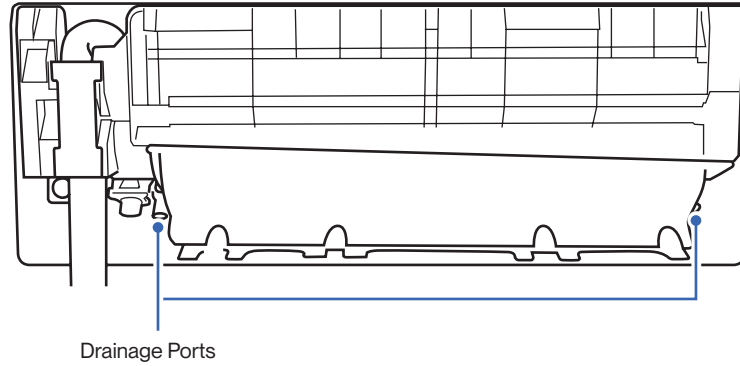

Drain Hose Installation

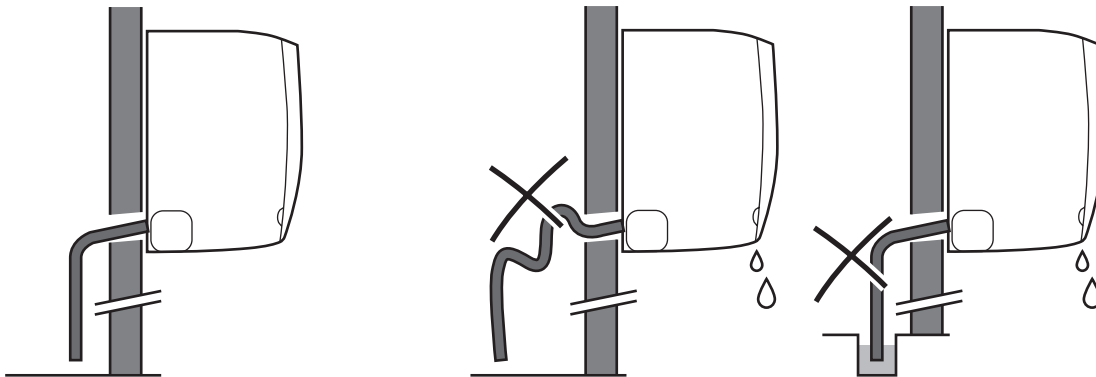

- Drain hose must be slanted downward and leave a small gap between the ground and the hose.



- Avoid having bends or dents on the drain hose.
- Do not leave the end of the hose into drainage gutter.

Indoor Unit Installation

Pass Electric Cable Through the Indoor Unit

1. Open the front panel of the indoor unit.
2. Remove the control box cover from the control box.
3. Pass the electric cable from the back of the indoor unit to the control box.
4. Leave enough length of the electric wire in the control box for connection in a later step.

Page 25

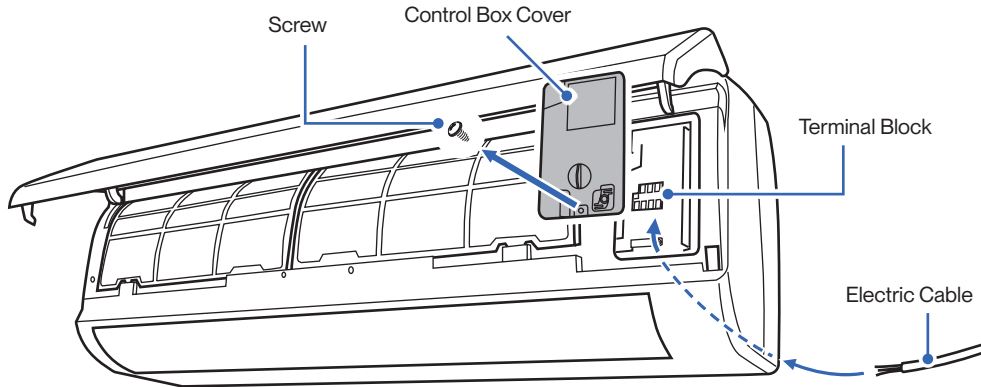

Bundle the Indoor Unit Refrigerant Pipes, Hose, and Cable

Refrigerant Pipes, drain hose, and electric cable must be properly arranged and bundled with insulation tape before passing them through the wall hole.

1. Arrange the refrigerant pipes, drain hose, and electric cable according to the image below.
2. Wrap the bundle with insulation pipe.

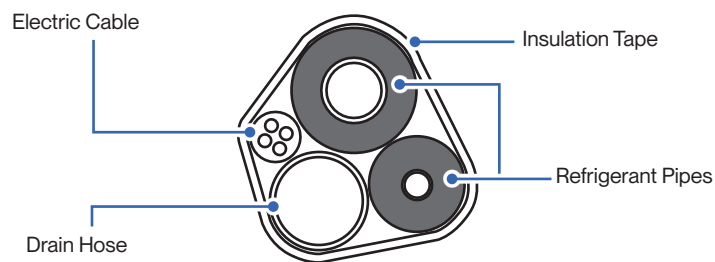

- Drain hose must be positioned at the bottom to prevent water leakage.

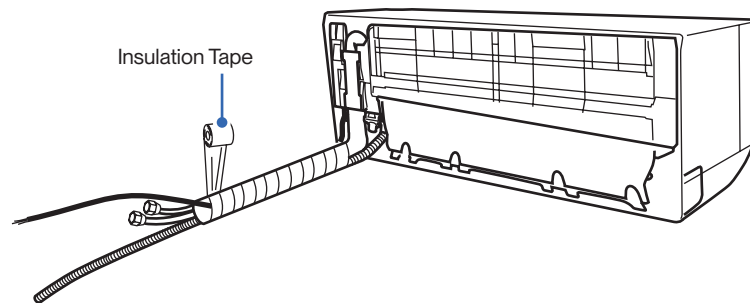

Indoor Unit Installation

Pass Line Set Through Wall Hole and Mount Indoor Unit

1. Carefully pass the line set bundle through the wall hole.
2. Hook the top of the indoor unit on the mounting plate.
Push the unit lightly left and right to make sure it is firmly hooked on the mounting plate.
3. Push down the bottom of the indoor unit and snap into the mounting plate.

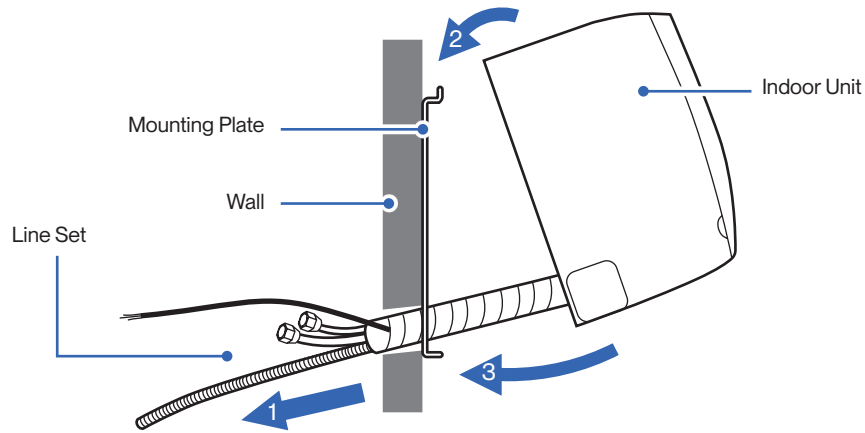

Pass Line Set Through Wall Hole and Mount Indoor Unit (Left Piping Direction)

If you choose to have the piping direction on the left side of the indoor unit,

1. Carefully pass the drain hose and electric cable through the wall hole.
2. Hook the top of the indoor unit on the mounting plate.
Push the unit lightly left and right to make sure it is firmly hooked on the mounting plate.
3. Place a wedge or foam block or something slightly soft between the mounting plate and the indoor unit for an easier installation process in later steps.

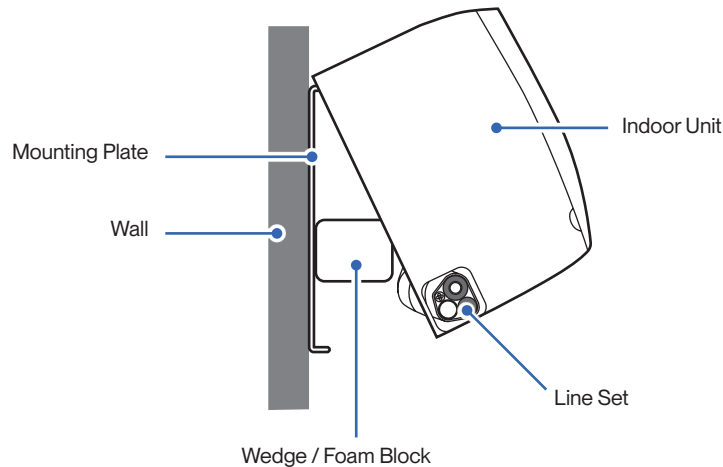

- The indoor unit is not secured in place at this step for left side piping direction installation.
Handle the unit and line set with caution. It is recommended to have a person looking after the unit and make sure it does not fall during the later installation process.

Outdoor Unit Installation

Secure the Outdoor Unit (Ground Installation)

1. Place a concrete pad on the installation location.
NOTE: You do not need a concrete pad if the ground is concrete.
2. Mount the indoor unit on a mounting stand or base kit.
NOTE: Rubber foot pads can be placed between the outdoor unit and the mounting kit to reduce vibration or noise.
3. Drill holes on the concrete pad or concrete ground.
4. Secure the mounting stand or base kit on the concrete with concrete anchor bolts.

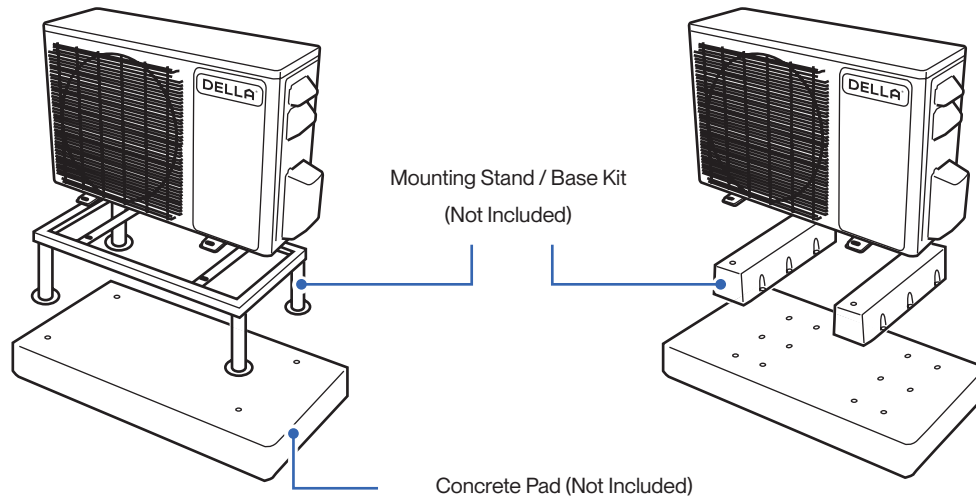

- Outdoor unit should be installed on a elevated mounting stand with snow cover if using in a snowy region.

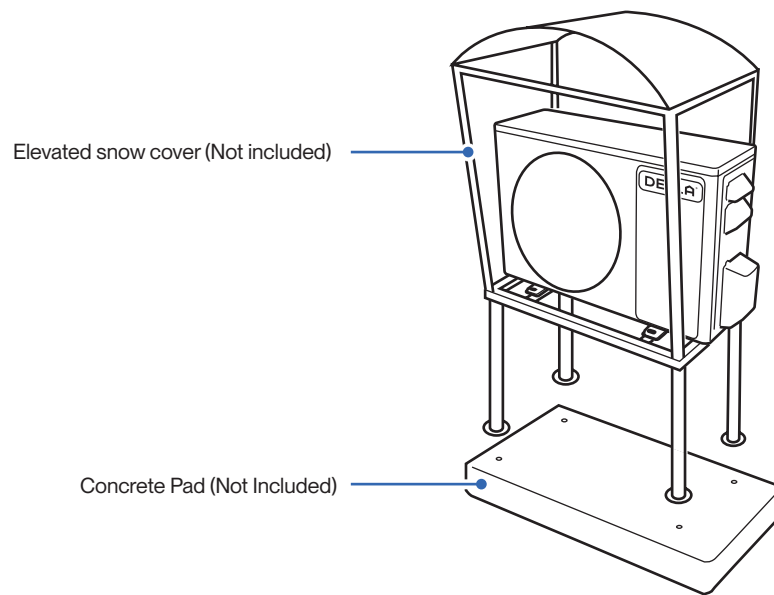

Outdoor Unit Installation

Secure the Outdoor Unit (Wall Installation)

The outdoor unit can be fixed on a wall mounting bracket if there is no ground mounting option.

1. Measure the distance between the outdoor unit's legs.
2. Mount the wall mounting bracket on the wall.
3. Secure the outdoor unit on the wall mounting bracket.

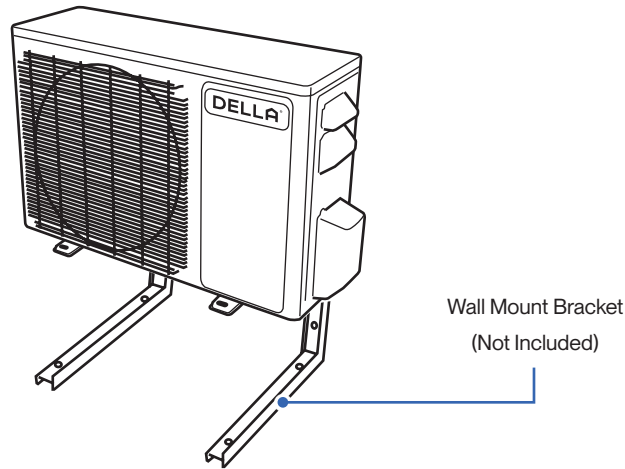

- The wall mounting bracket and the wall must be able to support at least 4 times the weight of the outdoor unit.

Attach Drainage Port and Hose

Outdoor unit drainage helps prevent condensation or frost inside the unit during cold weather.

1. Drainage joint installation is recommended for heat pump models.
2. Insert drainage joint into the bottom hole of the outdoor unit.
3. Connect one end of the drain hose to the joint and the other end to your desired drainage point.

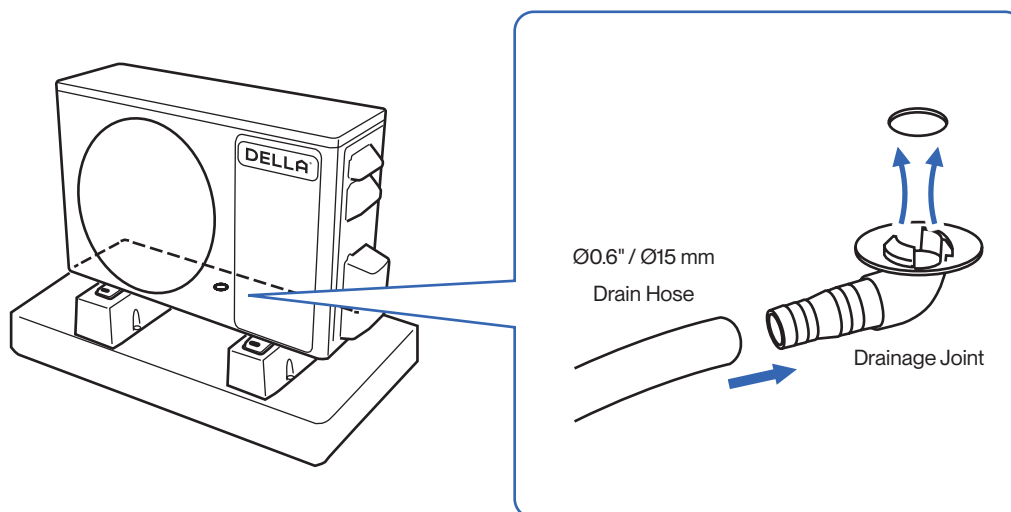

Indoor and Outdoor Unit Installation

Preparing the Refrigerant Pipe

1. Unroll the included refrigerant pipe.

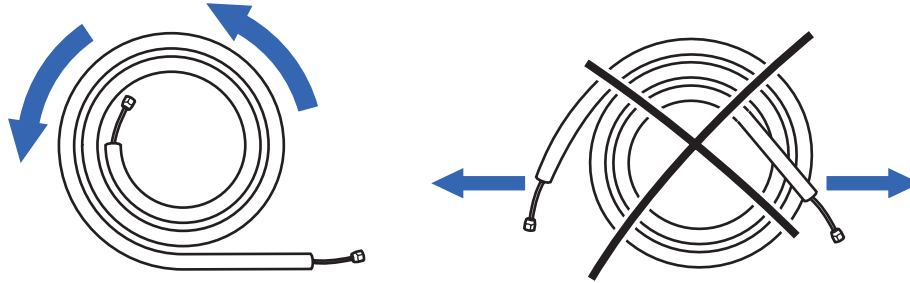

- Do not pull the refrigerant pipe to prevent the pipe from kinking or bending.

2. Remove the cover and make sure the ports are clean and smooth.

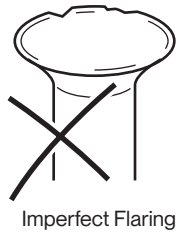

Imperfect Flaring

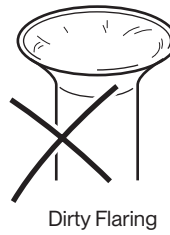

Dirty Flaring

3. In the case of a imperfect flaring or the pipe needs to be shorten for the installation, refrigerant pipe should be cut and flare by qualified technician.

Indoor and Outdoor Unit Installation

Cutting and Flaring Refrigerant Pipe



WARNING

- Any refrigerant pipe alteration should only be done by qualified technician. Incorrect work may cause refrigerant leak, reduce cooling / heating efficiency, damage to the unit. Warranty does not cover any damage(s) caused by incorrect refrigerant pipe alteration.

- Cut the copper pipe with a pipe cutter.
- Remove any burrs or rough edges with a reamer with the pipe facing downward.
NOTE: The opening of the pipe must face toward the ground to prevent chips or dust from entering the pipe.
- Insert the flare nut to the pipe.
- Use the flaring tool to flare the copper pipe. The flaring angle must match to that of the refrigerant lines from the unit.

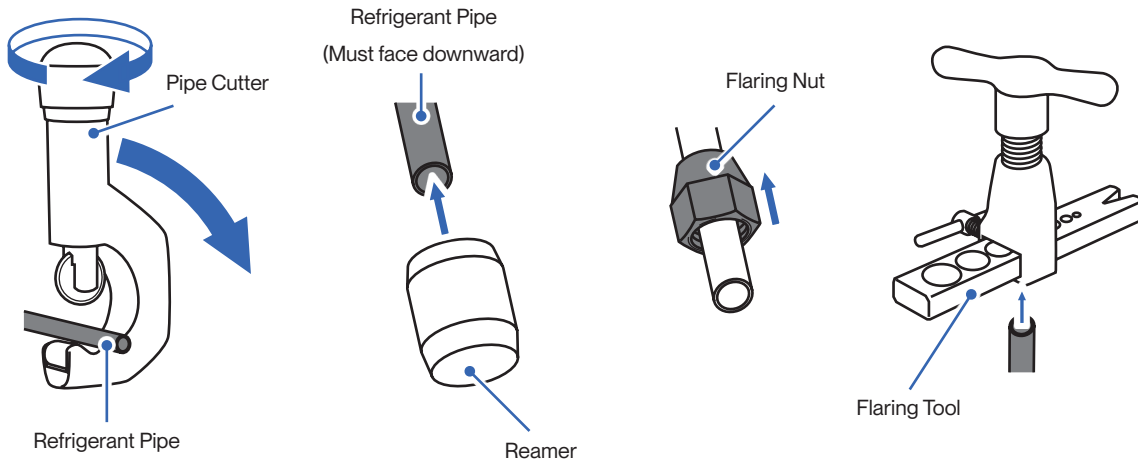

Indoor and Outdoor Unit Installation

Connect the Refrigerant Pipes to the Indoor Unit

- Align the refrigerant pipes to that from the indoor unit, then tighten the nut by hand.
- Use a torque wrench to tighten the nut according to the torque requirement.



- A thin layer of nylog can be applied to the inside of the flare to provide better seal. (OPTIONAL)
- Make sure no nylog is on the outside of the flare.

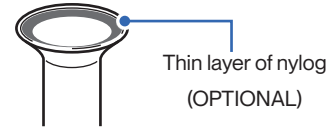

Connect the Refrigerant Pipes to the Outdoor Unit

- Unscrew the screws on the valve cover, press it down gently and remove the cover from the outdoor unit.
- Remove plastic caps from the end of the valves.
- Align the refrigerant pipes to the outdoor unit valve, then tighten the nut by hand.
- Use a torque wrench to tighten the nut according to the torque requirement.

Indoor Unit Connection

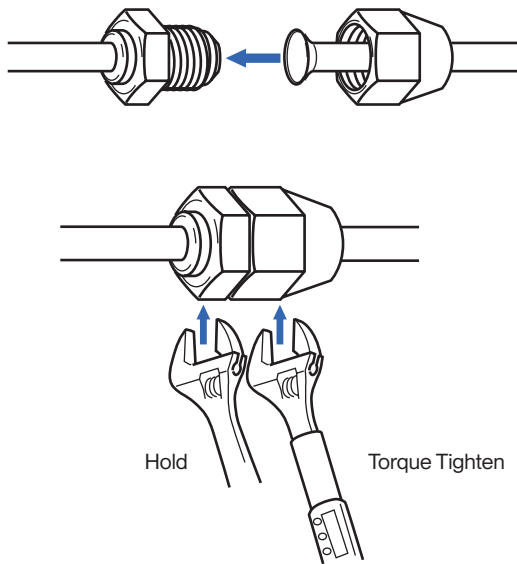

Outdoor Unit Connection

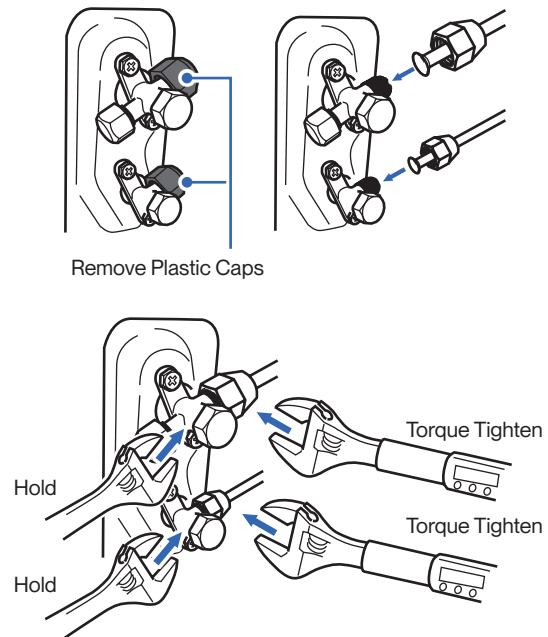

Pipe Diameter	1/4"	3/8"	1/2"	5/8"
Torque Parameter	18 - 20 N-M 13.3 - 14.8 lbf-ft 1.8 - 2.0 kgf-m	30 - 35 N-M 22.1 - 25.8 lbf-ft 3.0 - 3.6 kgf-m	45 - 50 N-M 33.2 - 36.9 lbf-ft 4.6 - 5.1 kgf-m	60 - 65 N-M 44.3 - 48.0 lbf-ft 6.1 - 6.6 kgf-m



- Connection must be torque tighten to prevent leak. Do not over tighten.
- Refrigerant piping and torque requirement for specific model is on [Page 13](#).

Indoor and Outdoor Unit Installation

Connect the Electrical Wire



WARNING

- Electrical wiring must be done by a qualified technician or electrician. Failing to connect the wires correctly will cause short circuit, a fire, and property damage.

- Unscrew the cable clamp in the indoor unit.
- Connect wires to the corresponding terminal and secure the cable using the cable clamp.
- Reinstall the control box cover and close the indoor unit's front panel.
- Unscrew the screws from the wiring cover, press the cover downward gently, and remove from the outdoor unit.
- Unscrew the cable clamp.
- Insert the electrical cable from the indoor unit through the opening on the cover, then connect the wires to the outdoor unit terminal.
- Insert power supply cable to the opening on the cover, then connect the wires to the outdoor unit terminal.
- Turn off any power from the power supply, and connect the wires to the power supply circuit box.

For exact breaker size requirement [Page 12](#)

- Reinstall the wiring cover to its original place.

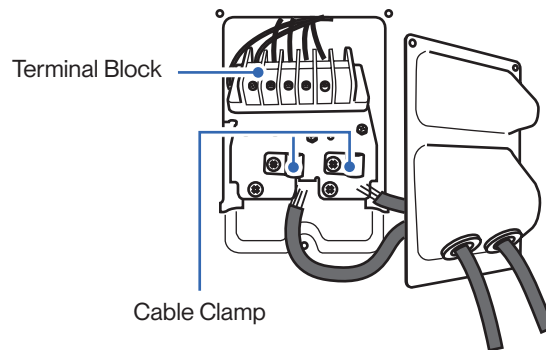
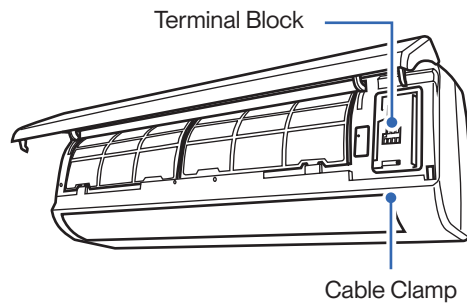

For 115V Unit

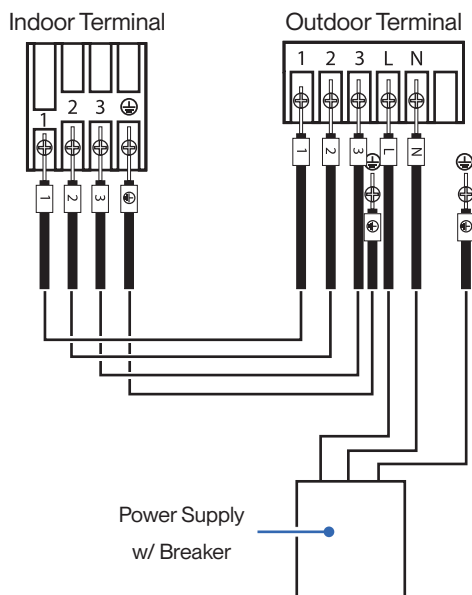

For 220V Unit

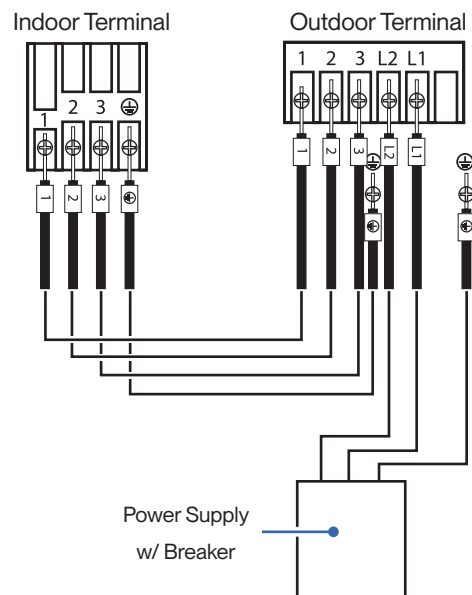

Indoor and Outdoor Unit Installation

Indoor Unit Circuit Diagram

- 048-TL-9K1V-19S-IN
- 048-TL-9K2V-19S-IN
- 048-TL-12K1V-19S-IN
- 048-TL-12K2V-19S-IN
- 048-TL-18K2V-19S-IN

Installation
Installation

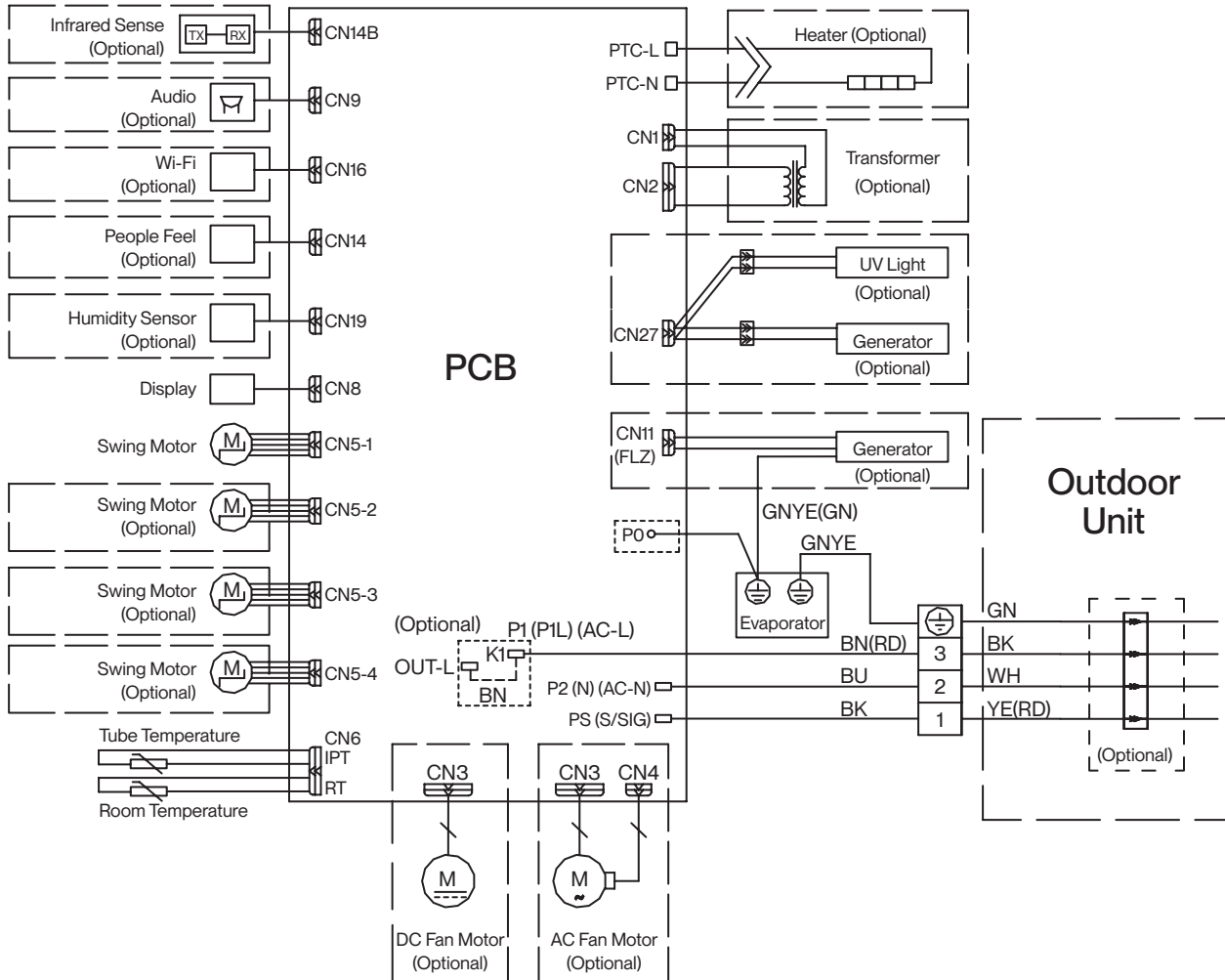

Indoor and Outdoor Unit Installation

Indoor Unit Circuit Diagram

048-TL-24K2V-19S-IN
048-TL-36K2V-19S-IN

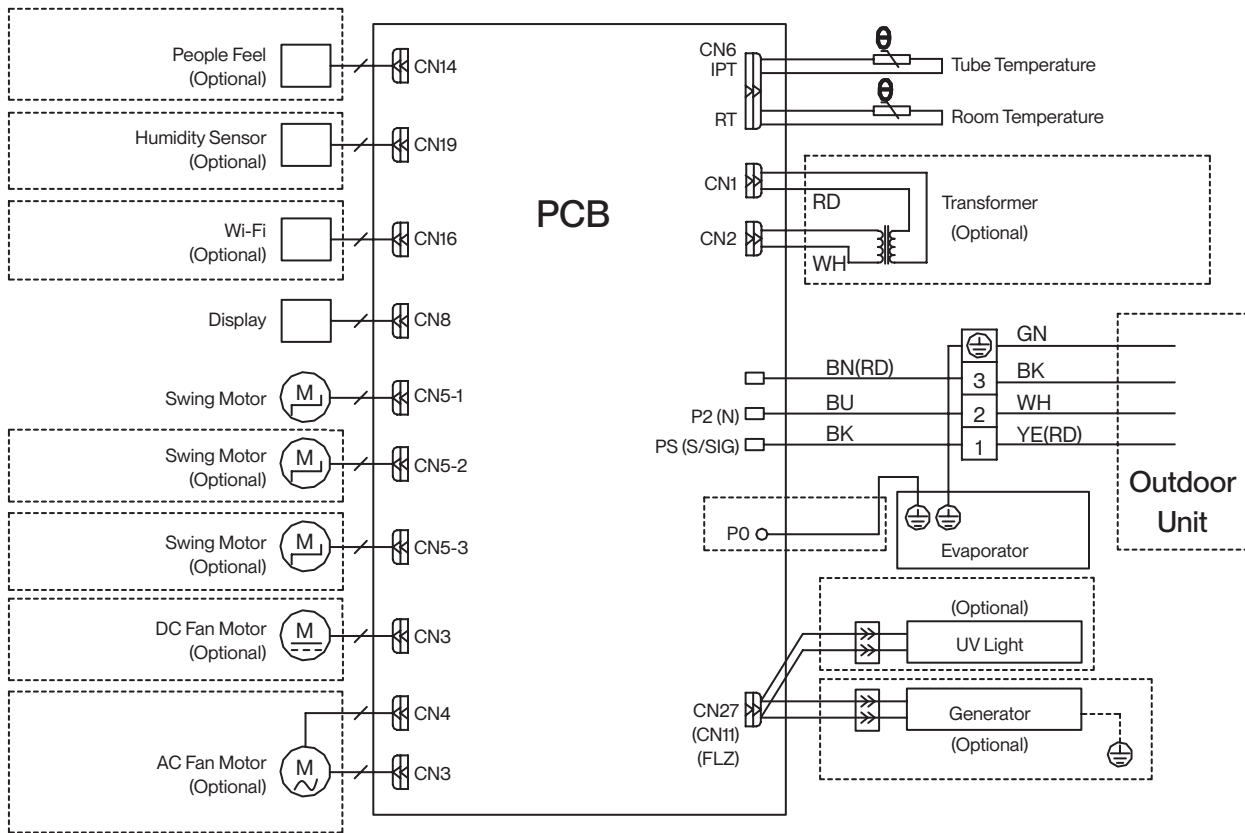

Installation
Installation

Indoor and Outdoor Unit Installation

Outdoor Unit Circuit Diagram

048-TL-9K1V-19S-OUT

048-TL-12K1V-19S-OUT

Installation
Installation

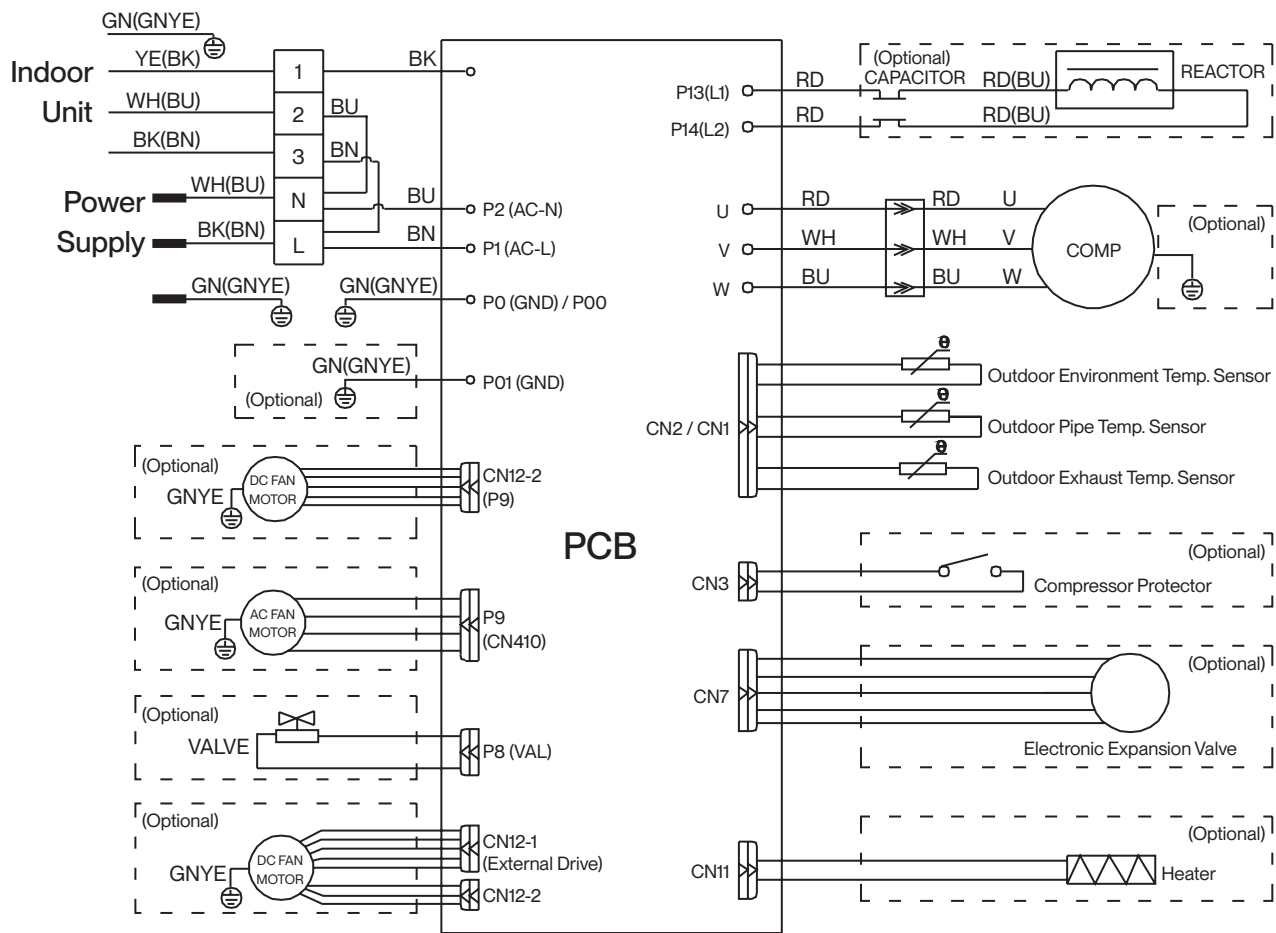

Indoor and Outdoor Unit Installation

Outdoor Unit Circuit Diagram

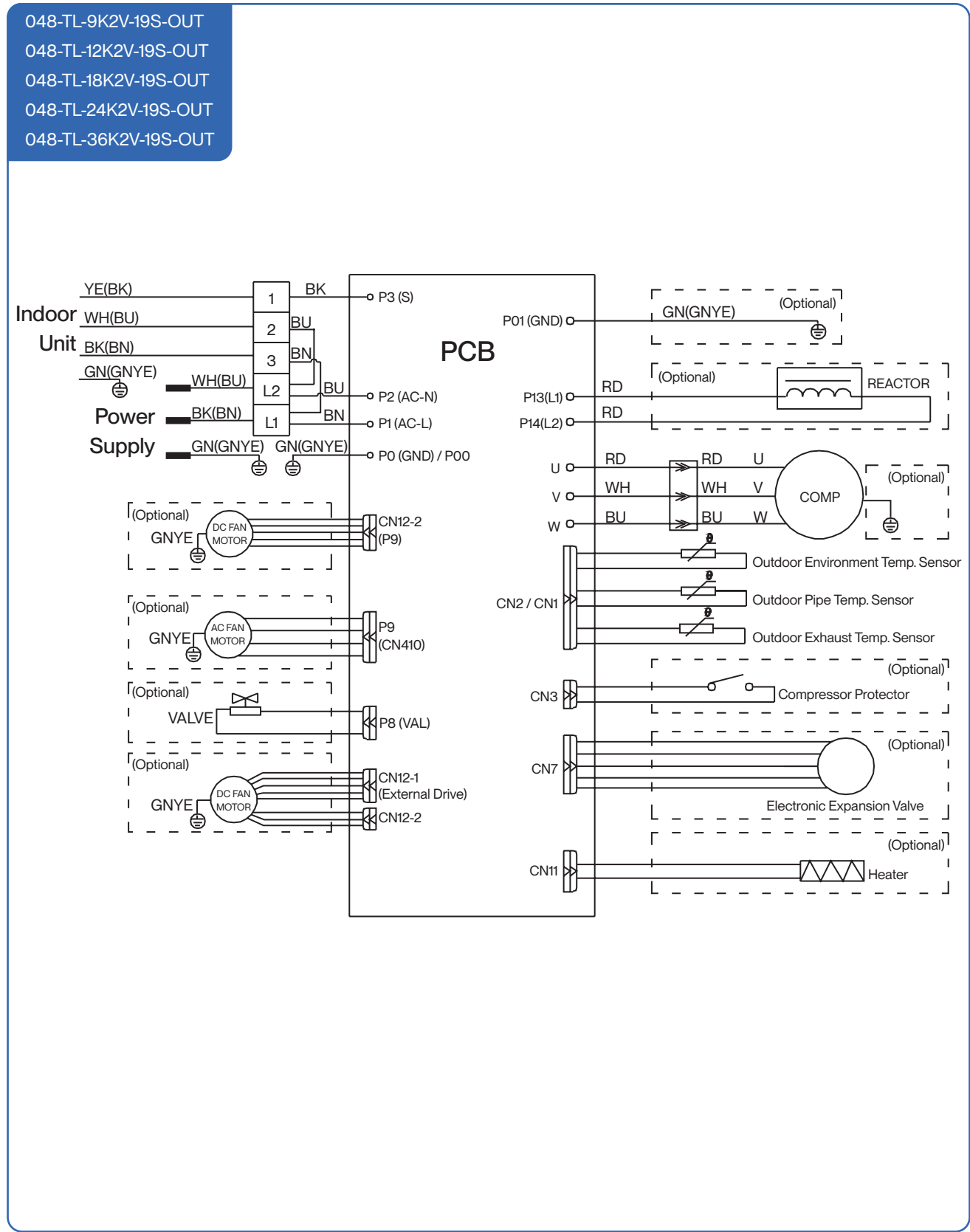

Indoor and Outdoor Unit Installation

Vacuum Pumping and Leak Test (Using Micron Gauge) *RECOMMENDED

1. Remove the protective caps from the service port, low-pressure valve (Lo-R), and high-pressure valve (Hi-R).
2. Connect the charging hose with a push pin to the service port.
3. Connect a the vacuum pump to the other end of the charging hose and the micron gauge in between the service port and the pump.
4. Open the valve adapter on the charging set, then turn on the vacuum pump to vacuum the system.
5. Let the vacuum pump run until the micron gauge indicate the value of 500 micron or lower.
6. Close the valve adapter on the charging set and turn off the vacuum pump.
7. Leave the system connected with the micron gauge for 5 minutes, then make sure the gauge indication does not exceed 500 micron.

NOTE: In the case of a leak, and the micron level increases above 500 micron, reconnect all the connection joints on the refrigerant line, and redo the vacuum pumping.

8. Disconnect the pressure hose and the micron gauge from the service port.
9. Add refrigerant charge if you use a lengthened refrigerant line.

Page 13

10. Turn on the air conditioner and confirm it can power on properly, and then turn it off.

Page 44

11. Fully open the low pressure valve (Lo-R) and high pressure valve (Hi-R)
12. Put the protective caps back on the service, low-pressure valve, and high-pressure valve.
13. Tighten the caps.



- Do not open the refrigerant valve before vacuum pumping.
- Stop and disconnect the vacuum pump from the system before opening the refrigerant valve.

Indoor and Outdoor Unit Installation

Micron Gauge Connection

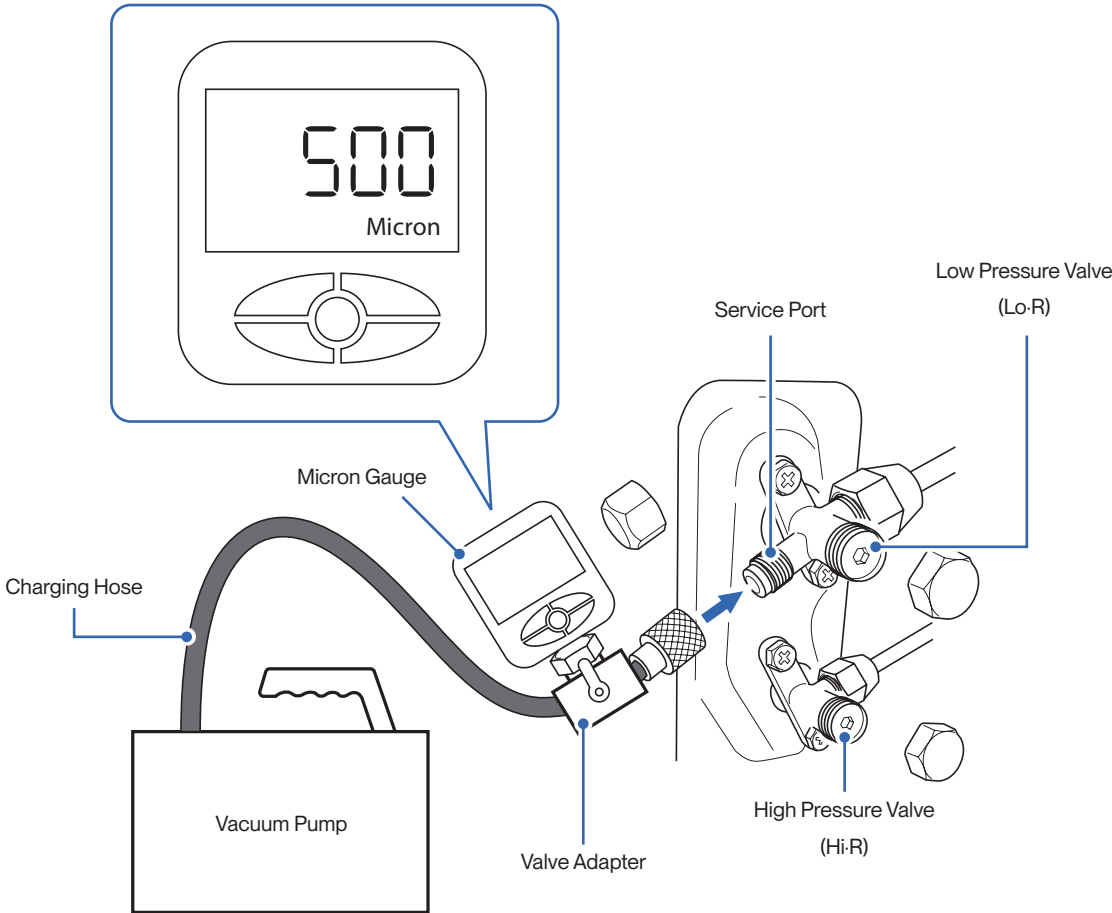

Indoor and Outdoor Unit Installation

Vacuum Pumping and Leak Test (Using Manifold Gauge)



- Analog manifold gauge is less accurate and measure vacuum at a lower resolution than a digital micron gauge. DELLA recommend using micron gauge for vacuum pumping mentioned on [Page 30](#)

1. Remove the protective caps from the service port, low-pressure valve (Lo-R), and high-pressure valve (Hi-R).
2. Connect the pressure hose with a push pin from the manifold gauge to the service port.
3. Connect the charging hose from the manifold gauge to the vacuum pump.
4. OPEN the low-pressure valve (Lo-M) and CLOSE the high pressure valve (Hi-M) on the manifold gauge.
5. Turn on the vacuum pump to vacuum the system.
6. Let the vacuum pump run for at least 15 minutes and make sure the gauge indicates -0.1 Mpa (-76 cmHg).
NOTE: Depending on your refrigerant line set length and vacuum pump power, it might takes longer time.
7. Close the pressure valve (Lo-M) and turn off the vacuum pump.
8. Leave the system connected with the manifold gauge for 5 minutes, then make sure the gauge indication does not exceed 0.005 Mpa.
NOTE: In the case of a leak, and the pressure value increases, reconnect all the connection joints on the refrigerant line, and redo the vacuum pumping.
9. Open the high-pressure valve (Hi-R) for $1/4$ turn, then close the valve after 5 seconds.
10. Check all connection joints with refrigerant leak detector or liquid leak detector.
11. Add refrigerant charge if you use a lengthened refrigerant line.
[Page 13](#)
12. Turn on the air conditioner and confirm it can power on properly, and then turn it off.
[Page 44](#)
13. Disconnect the pressure hose from the service port, then fully open the low pressure valve (Lo-R) and high pressure valve (Hi-R).
14. Put the protective caps back on the service, low-pressure valve, and high-pressure valve.
15. Tighten the caps.



- Do not open the refrigerant valve before vacuum pumping.
- Stop and disconnect the vacuum pump from the system before opening the refrigerant valve.

Indoor and Outdoor Unit Installation

Manifold Gauge Connection

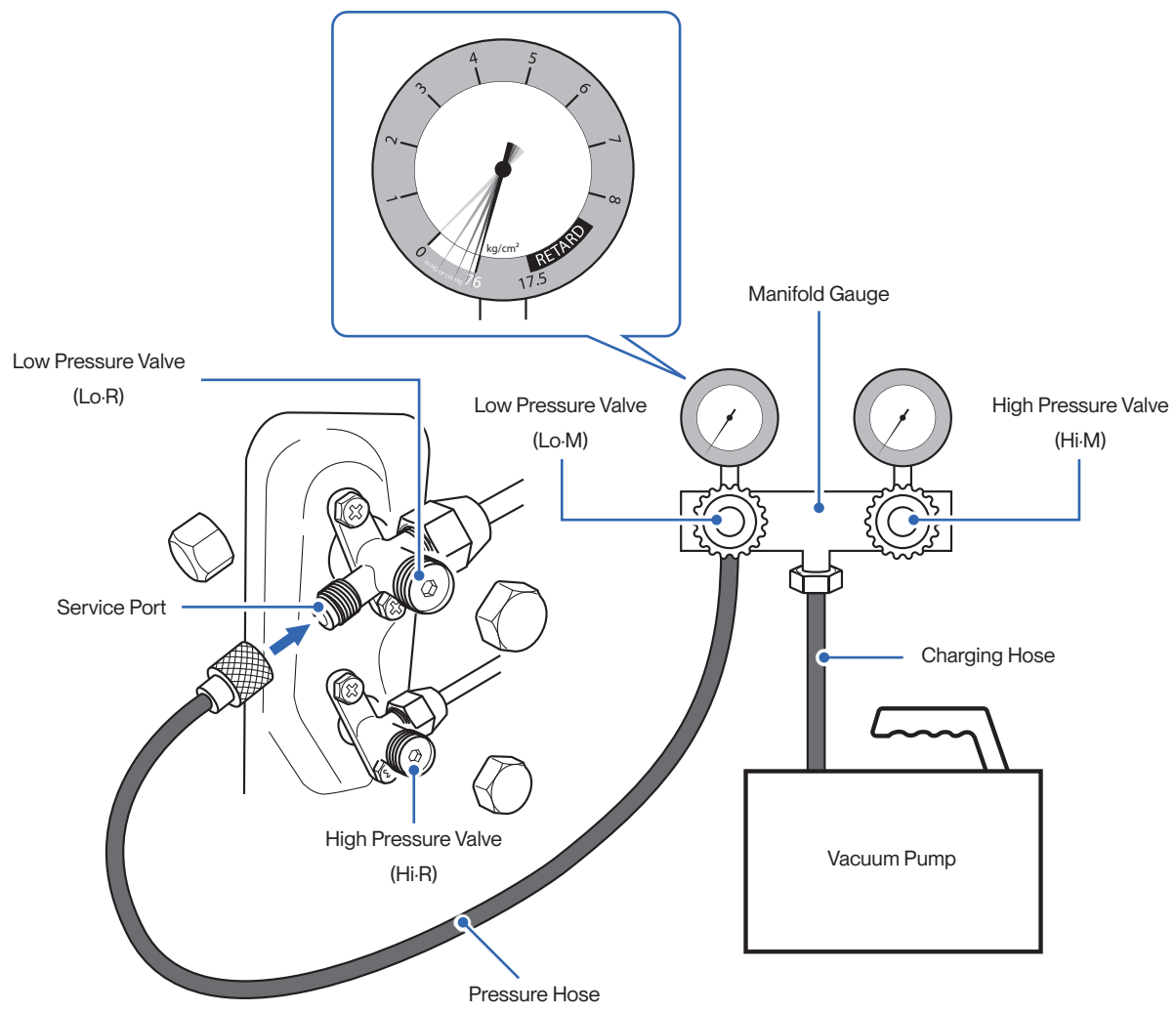

Installation
Installation

Finishing

Line Set Insulation, Bundling, and Finishing Touch

Refrigerant Pipes, drain hose, and electric cable must be properly arranged and bundled with insulation tape to maximize the unit's efficiency and prevent condensation or water leak.

Installation
Installation

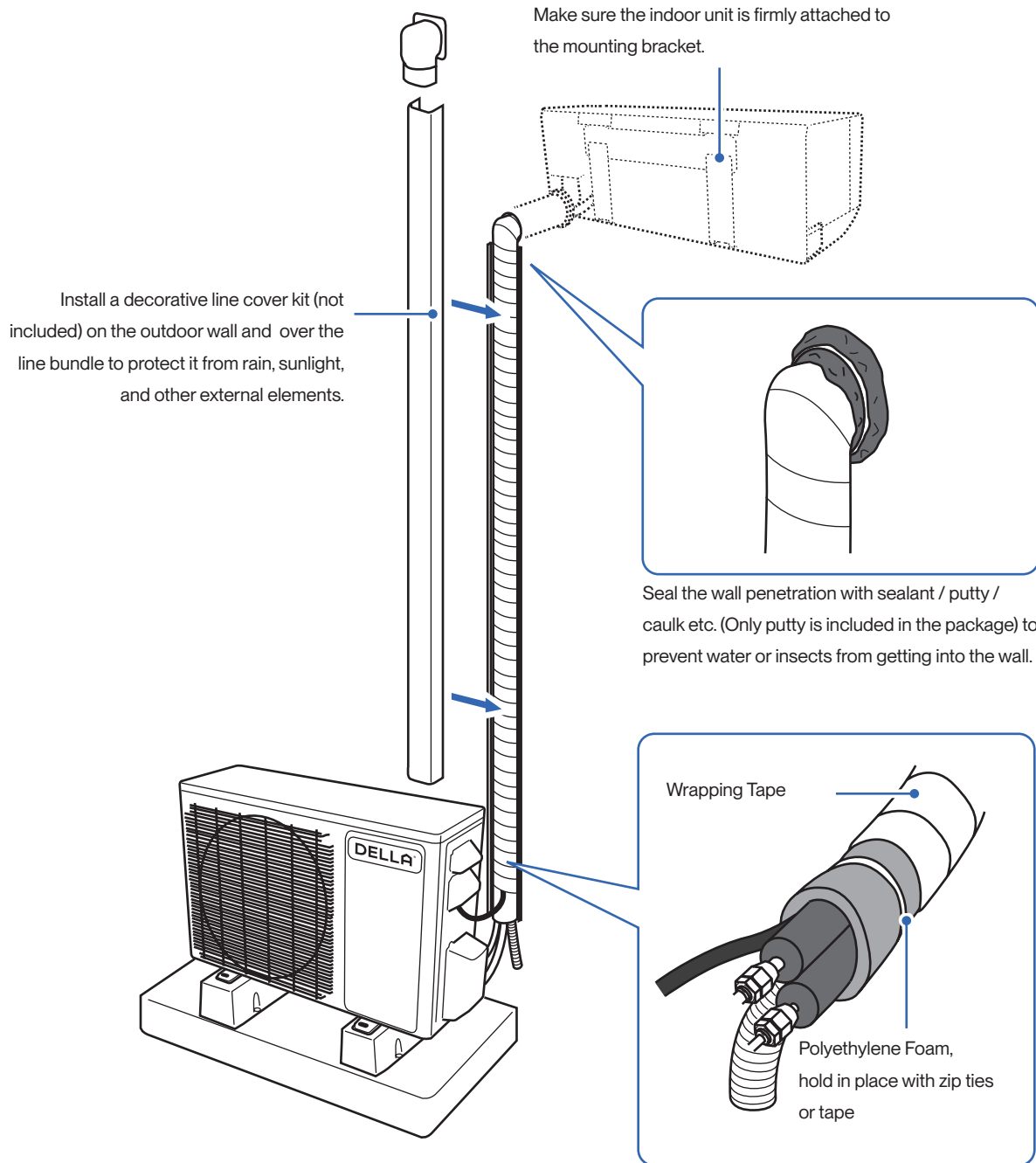

QUICK TIPS

- When wrapping and bundling the line set, avoid over tightening to prevent the insulating materials from over compression.
- Make sure all connection joints are properly insulated.

Finishing

Check List

Go through the following list and check your installation.

the check box for each confirmation.

Check List	Status
Are the indoor and outdoor unit kept at least the minimum distance away from the closest wall and obstacle?	<input type="checkbox"/>
Is the indoor mounting plate secured?	<input type="checkbox"/>
Are all the panels on the unit secured and would not fall out?	<input type="checkbox"/>
Is the drain hose properly attached?	<input type="checkbox"/>
Are the refrigerant pipes securely connected and no refrigerant leakage?	<input type="checkbox"/>
Are all pipes, hoses, and cable bundled and wrapped with insulation tape?	<input type="checkbox"/>
Is the system properly vacuumed?	<input type="checkbox"/>
Is all the wall opening sealed off?	<input type="checkbox"/>
Are the refrigerant valves fully opened?	<input type="checkbox"/>
Do the power supply and voltage match the unit rating? (Check before connecting to power supply)	<input type="checkbox"/>
Is the electrical wiring in the unit connected and secured?	<input type="checkbox"/>
Are the units properly grounded?	<input type="checkbox"/>
Is the power breaker, fuse, or protection device installed?	<input type="checkbox"/>
Can the remote control send control commands to the air conditioner?	<input type="checkbox"/>



- Any failures, accidents, or damages caused by improper installation are not covered by the warranty.

Finishing

Test Run

Refrigerant Pipes, drain hose, and electric cable must be properly arranged and bundled with insulation tape to maximize the unit's efficiency and prevent condensation or water leak.

1. Turn on the power supply.
2. Turn on the air conditioner using the remote control.
3. Test the unit at the lowest temperature in COOL mode.
4. Test the unit at the highest temperature in HEAT mode.
5. Test each mode for at least 8 minutes.
 - Measure the air temperature at the air outlet.
 - Check if water drains properly from the drainage hose.
 - Check if the louver and deflectors move properly.
6. If everything is operating normally, return to normal setting and turn off the air conditioner.
7. Inform the user to read the operation instruction before use, and demonstrate to the user how to use the air conditioner, the necessary knowledge of service and maintenance, and a reminder of accessories storage.



- If the ambient temperature exceed the normal operation range, lift the front panel and use the emergency button to run COOL and HEAT modes.



Contact us if you encounter any problems during or after the installation.



support.dellahome.com/en-US



800-863-4143
6:00 a.m. - 4:00 p.m. PST
Monday - Friday



24/7 Live Chat

Before Using

Operation Tips

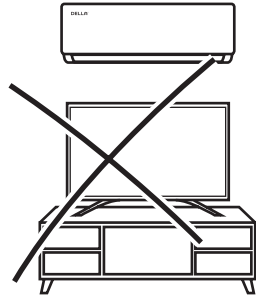

Avoid placing TV, radio or large furniture under the air conditioner.

- It may block wind flow or interfere with the remote control.

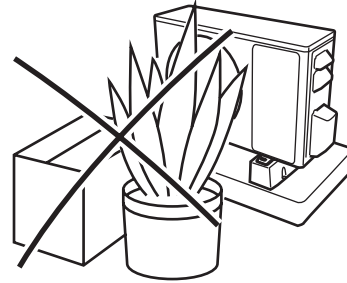

Avoid putting plants or objects around the outdoor unit.

- It may lower the air conditioner efficiency or cause malfunction.

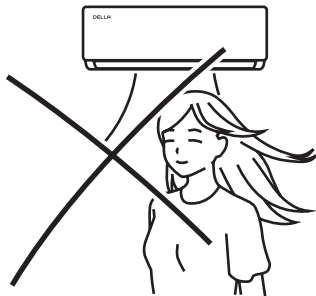

Avoid direct wind flow to people, pets, or plants.

- Expose to direct wind flow for extended period of time may have a negative impact on your health.

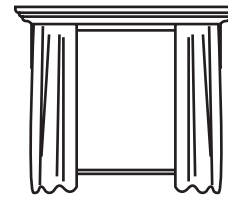

Close windows and blinds.

- The air conditioner can cool or warm the area with better efficiency.

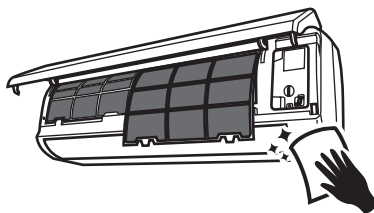

Follow cleaning and maintenance routine.

- Regular cleaning and maintenance are needed for the best efficiency and prevent bad odor or water leak.

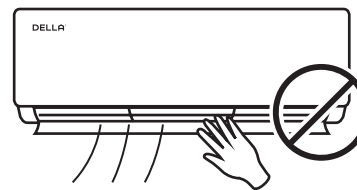

DO NOT manually adjust the deflector and flaps.

- It may cause injury to the user and damages to the air conditioner.

Before Using

Indoor Unit and Front Panel

Before Using
Before Using

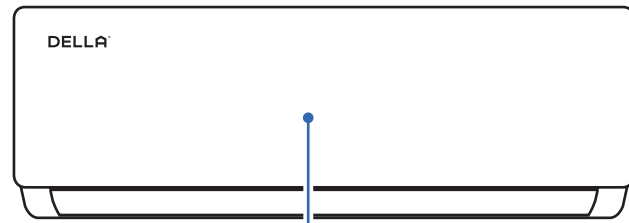
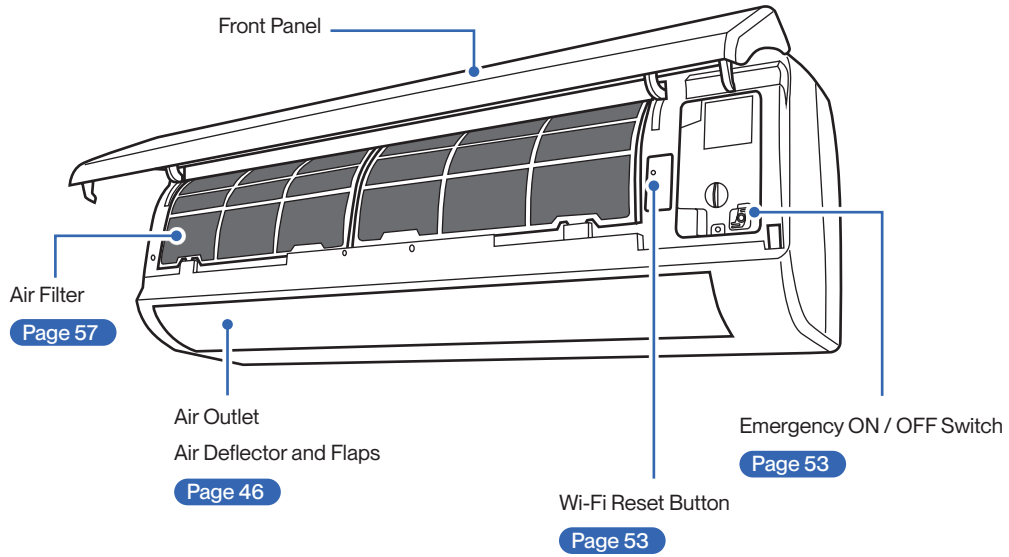

Display

LED Indicator	Function
88	Lights up when the unit is turned on and operating Indicator for temperature, timer, and error codes
⏰	Lights up when timer is enabled
🌙	Lights up when SLEEP mode is enabled

NOTE: The graphical representation might have slight differences than the actual product.

Before Using

Remote Control (Inserting Battery)

1. Remove the back cover.
 2. Insert 2 LR03 AAA 1.5 v batteries into the remote control.
 3. Reinstall the back cover.
- After new batteries are inserted into the remote control, the display screen will lights up for 3 seconds. Leave it for 10 seconds, the display will automatically turn off.
 - The default temperature unit will automatically turn into degree Fahrenheit.
To change temperature unit, follow instruction on [Page 52](#).



- Do not use rechargeable batteries.
- Replace the old batteries with new ones of the same type.
- Do not dispose batteries as unsorted municipal waste.

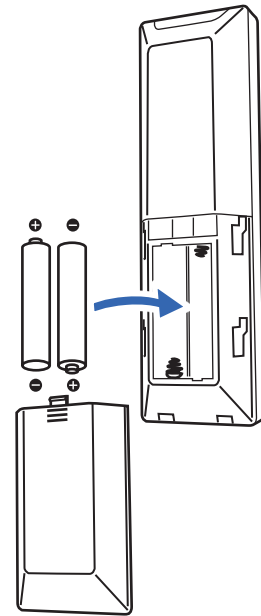

Remote Control (Remote Control Holder)

1. Attach the remote control holder to a wall by using the double sided adhesive tape or provided screws.
NOTE: Wall anchor might needed if you install it on a dry wall.
2. Insert the remote control into the holder.



- Avoid exposing the remote control to direct sunlight.

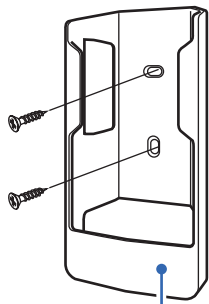
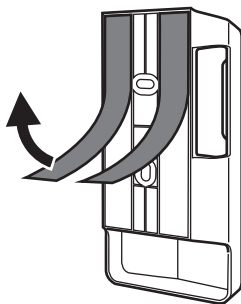

Remote Control Holder

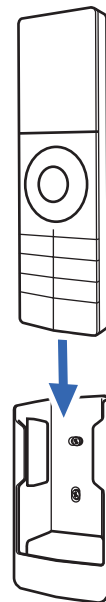



Just Right, Always.

Made to live with you, Della puts controls in your hands so that you can easily dail in a stress-free space that helps you feel more you.



Before Using

Remote Control

Before Using
Before Using

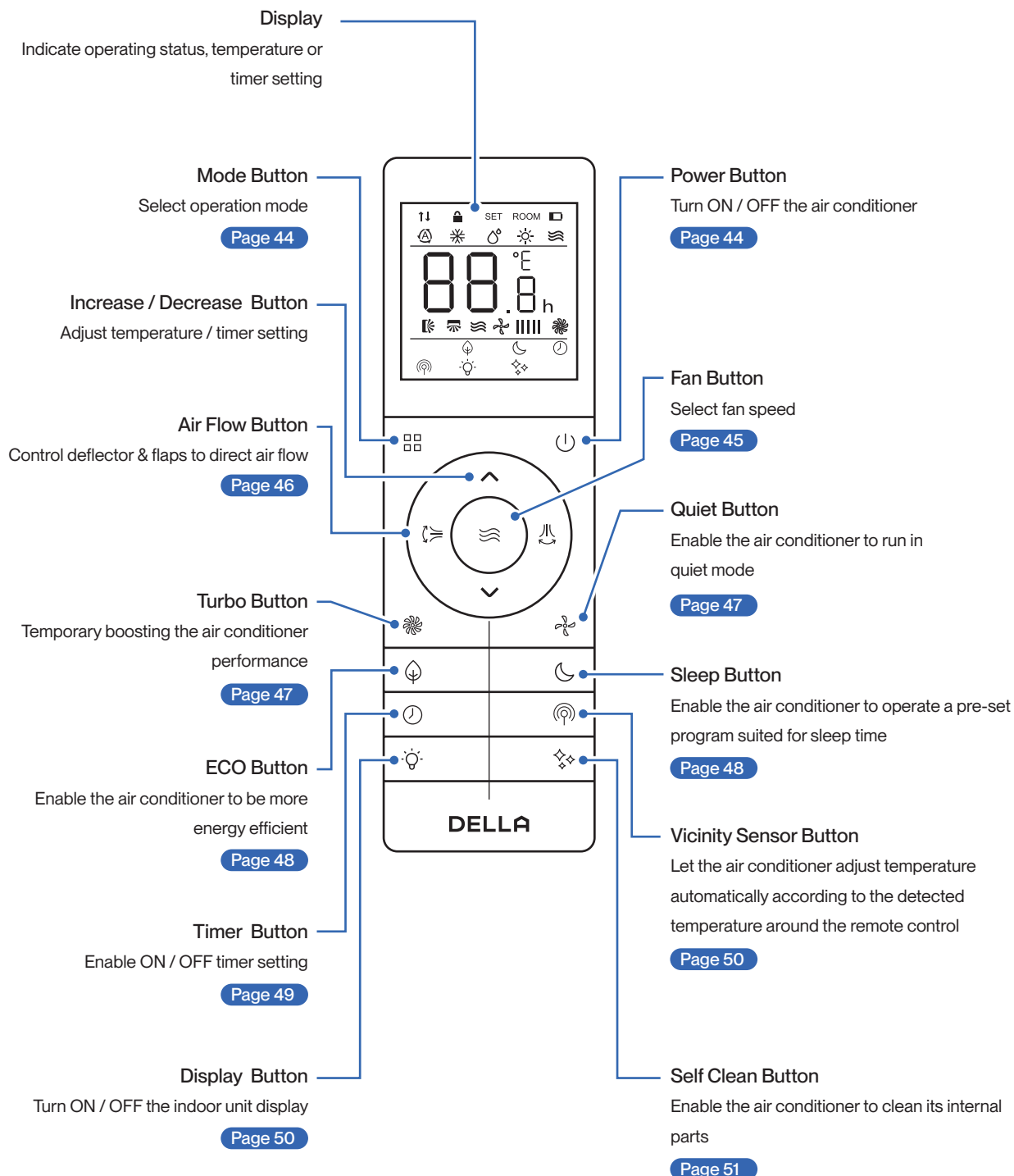

Before Using

Remote Control

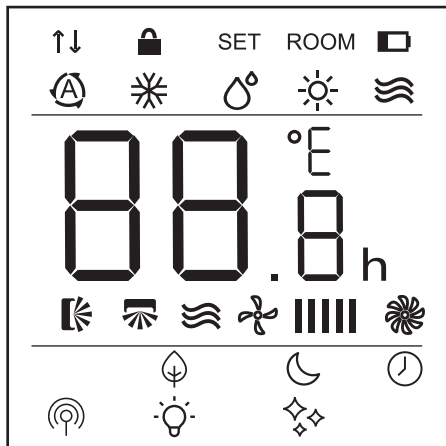

Before Using
Before Using

LED Indicator	Function
	Signal Indicator
	Child Lock
SET	Indicate Set Temperature
ROOM	Indicate Room Temperature
	Low Battery
	Auto Mode
	Cool Mode
	Dehumidify Mode
	Heat Mode
	Fan Mode
88.8	Indicate Temperature Value
°F °C	Temperature Unit Degree Fahrenheit / Celsius

LED Indicator	Function
	Horizontal & Vertical Air Flow Indicator
	Quiet Mode
	Fan Speed
	Turbo Mode
	Eco Mode
	Sleep Mode
	Timer
	Vicinity Sensor Mode
	Indoor Unit Display Indicator
	Self Clean

Basic Operation

Basic Operation
Basic Operation

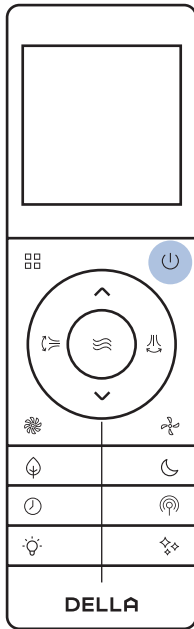

Power ON

Press .

- The air conditioner will start operating.

Power OFF

Press .

- The air conditioner will stop operating.

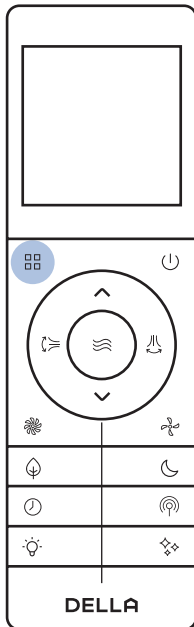



Select Operation Mode

Press  to select operation mode.



- It may take a few minutes for the air conditioner to switch between modes.
- During Heat mode, the air conditioner can automatically activate defrost cycle, which is essential to remove frost on the condenser for heat exchange function. This procedure usually lasts for 2 - 10 minutes. When defrosting, indoor unit fan will stop operating. Once defrosting is completed, it will resume heat mode automatically.

Auto mode operation

Set temp. < Room temp.	 Cool
Set temp. > Room temp.	 Heat
Set temp. = Room temp. ± 1.8°F / 1°C	 Fan

- Auto mode allows the AC to automatically select operation mode based on the above logic.
- Each mode will operate for at least 6 minutes before switching.
- Auto mode does not support sleep mode and eco mode operation.

Basic Operation

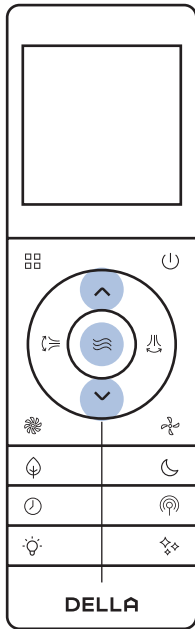

Adjust Temperature

Press to adjust temperature setting .

- Temperature setting will adjust by 1°F / 1°C increment for each time the button is pressed.
- Press and hold the buttons to adjust temperature continuously.
- Temperature can only be set between 61°F - 88°F / 16°C - 31°C.

Set Fan Speed

Press to select your desired fan speed.

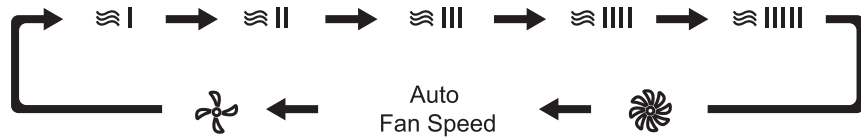

Basic Operation
Basic Operation

	Auto	Cool	Dehumidify	Heat	Fan
Temperature Setting	61°F - 88°F / 16°C - 31°C				N/A
Fan Speed	All Fan Speed	All Fan Speed	only	All Fan Speed	All Fan Speed

Basic Operation

Basic Operation
Basic Operation

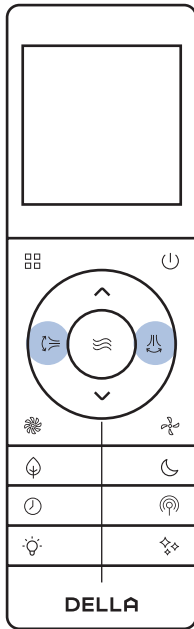

Adjust Air Flow

Press to oscillate horizontal flaps.



Press one more time. → The flaps will stop at the position it was in when you pressed the button.

Press and hold for 3 second.

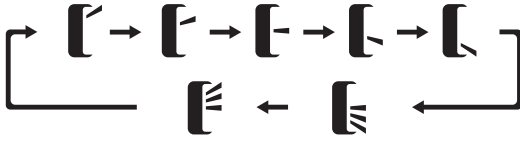

Press to select 1 of the 5 fixed positions, upper oscillation, or lower oscillation.

Leave setting for 5 seconds and press again.

Press to oscillate vertical vanes.



Press one more time. → The vanes will stop at the position it was in when you pressed the button.

Press and hold for 3 second.

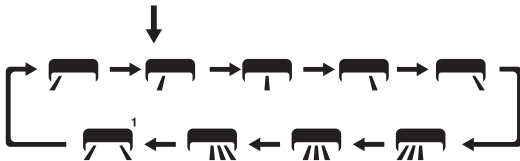

Press to select 1 of the 5 fixed positions, left oscillation, right oscillation, center oscillation or mirror symmetric oscillation¹.

NOTE: ¹ Mirror symmetric oscillation is not be available on TL / IF/ TP model.

Leave setting for 5 seconds and press again.

QUICK TIPS

- When holding the horizontal flaps in place. It is recommended to hold the flaps in the up most position during cool mode. Vice versa, it is recommended to hold the flaps in the down most position during heat mode.



- Cold air tends to sink.

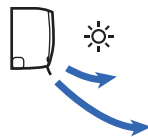

- Warm air tends to rise.

Advance Function

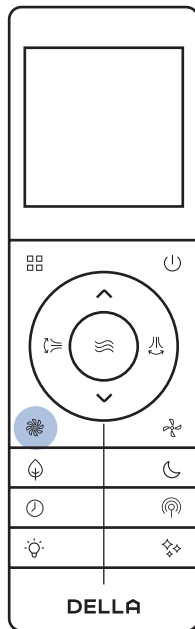





Turbo Mode

Using turbo mode can boost the air conditioner performance in a short amount of time.

Press .

- The air conditioner will operate in boosted fan speed.
- Turbo mode is not available when the air conditioner is operating in dehumidification mode.

To stop turbo mode, press  again or press  /  / .

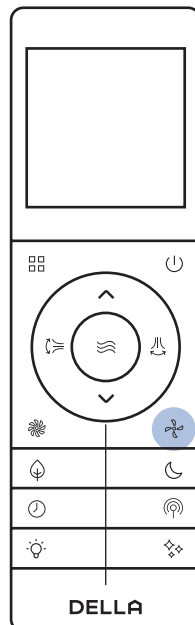





Quiet Mode

The air conditioner will operate at the minimum noise level under quiet mode.

Press .

- The air conditioner will operate in the lowest fan speed.
- Quiet mode is not available when the air conditioner is operating in dehumidification mode.

To stop quiet mode, press  again or press  /  / .

Advance Function

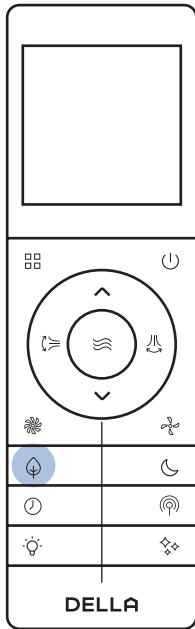

ECO Mode

The air conditioner will operate with maximum energy efficiency.

Press

- ECO mode is only available when the air conditioner is operating in cool or heat mode.
- The set temperature for cool mode and heat mode will be limited.

Press again or set the temperature beyond the ECO mode limit to cancel ECO mode.

	ECO + Cool	ECO + Heat
Temperature Setting	79°F - 88°F / 26°C - 31°C	61°F - 77°F / 16°C - 25°C

Advance Function
Advance Function

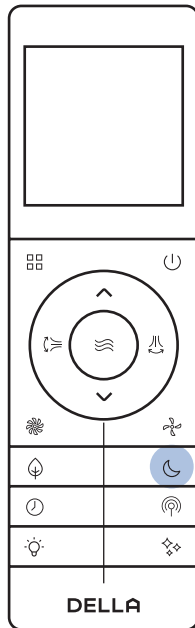

Sleep Mode

In sleep mode, the air conditioner will operate a pre-set program which is suitable during sleep.

Press

- Sleep mode will operate for 10 hours and then switch back to previously set mode.
- Sleep mode is not available when the air conditioner is operating in auto, dehumidify or fan mode.

Press again to stop sleep mode.

Sleep mode operation

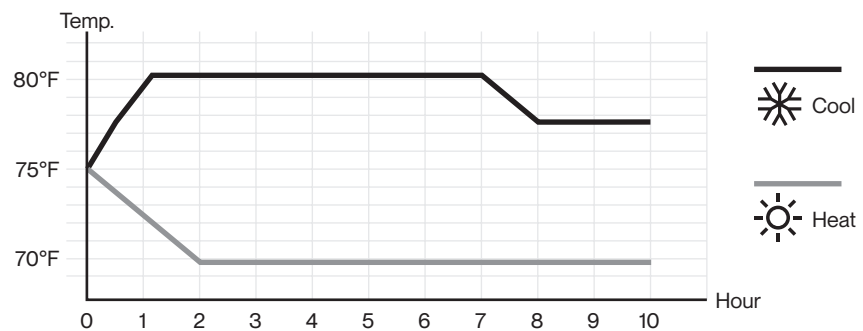

NOTE: This graph is for informational reference only. The actual product may change temperature at a different rate depending on the initial set temperature in sleep mode.

Advance Function

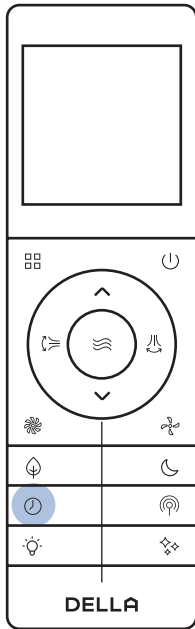

Timer Function (Shutdown Timer)

Set a timer to automatically turn OFF the air conditioner.

- Press when the air conditioner is ON.
- Press to set the desired turn off time.
- Press to confirm the timer setting.

Timer Function (Start-up Timer)

Set a timer to automatically turn ON the air conditioner.

- Press when the conditioner is OFF.
- Press to set the desired turn off time.
- Press , , and to select your desired operation mode, temperature setting, and fan speed for when the air conditioner is turn ON.

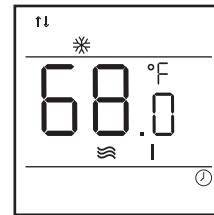
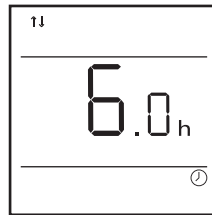

Press to confirm the timer setting.

QUICK TIPS

- Both the shutdown and start-up timer can be set between 0.5 - 24 hours.

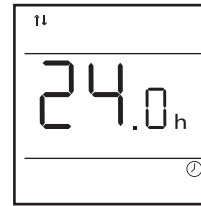
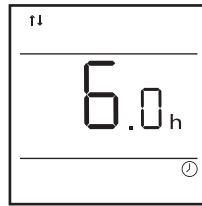
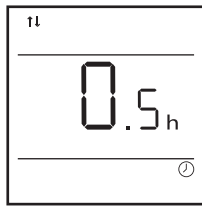

Timer default at 6 h

- While entering the setting, make sure to press the button within 5 seconds after the previous button was pressed. otherwise, the entire process will reset and you will have to start over.

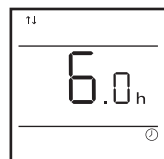

Timer Set

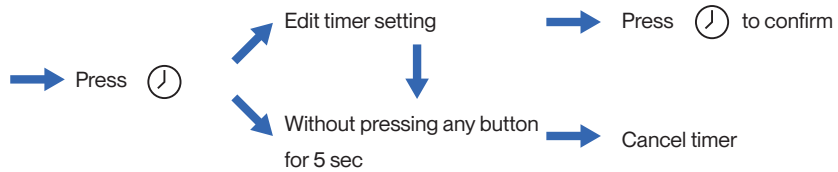

Advance Function

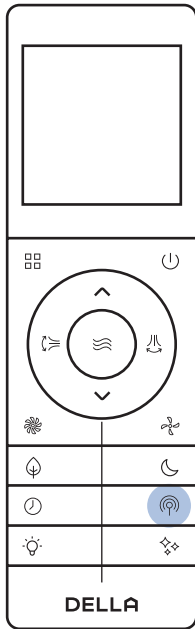

Vicinity Sensor

Vicinity sensor function turns your remote control into a portable thermostat that automatically controls the unit to adjust the temperature of the room you are in.

Press  to activate vicinity sensor function.

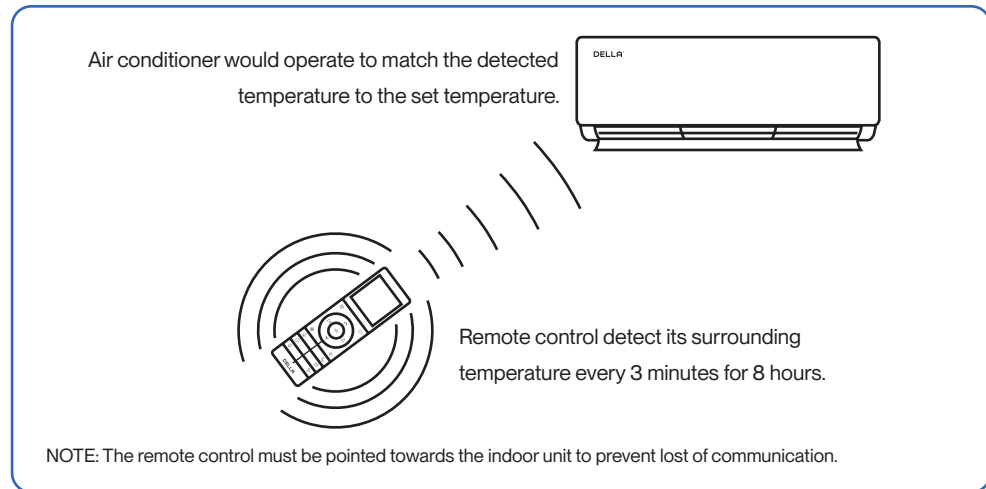

- In the case of the temperature detected by the remote control and the indoor unit thermostat has a difference greater than 11 °F / 6 °C, the AC would use the temperature data from the indoor unit for temperature adjustment, instead of that from the remote control.

Press  again to stop vicinity sensor function.

Display ON / OFF

Switch ON / OFF the LED display on the indoor unit front panel.

Press  to turn OFF the indoor unit display.

Press  again to turn ON the indoor unit display.

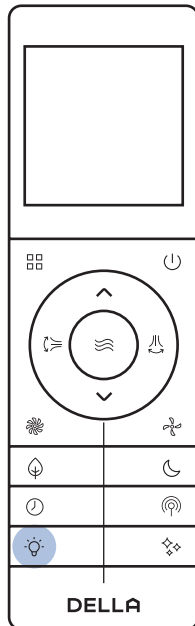

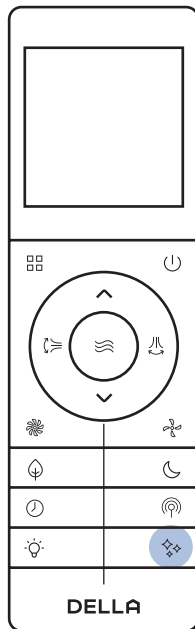

Advance Function



Self Cleaning

Self cleaning function allows the air conditioner to clean the interior parts and helps carry away the accumulated dirt, bacteria, etc. from the indoor evaporator.

Press  when the air conditioner is OFF.

-  will display on the indoor unit display.
- The self cleaning function will run for 30 minutes, then it will return to the previously operating mode once it is finish.
- It is recommended to operate this function when the indoor ambient temperature is under 86°F / 30°C, and the outdoor ambient temperature is between 41°F - 86°F / 5°C - 30°C.
- It is suggested to run the self cleaning function once every 3 months.
- It is normal that the unit makes some noise during self cleaning process as plastic materials expand and contract with temperature change.

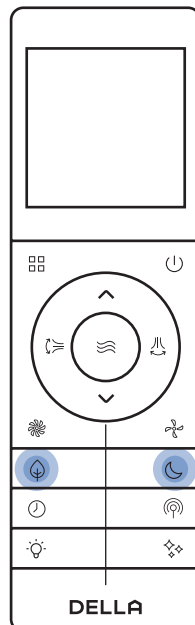

Child Lock

Child lock function will disable all input from the remote control until unlocked.

Press and hold  and  for 3 seconds to activate child lock.

-  will display on the remote control display.

Press and hold  and  for 3 seconds again to deactivate child lock.

Advance Function

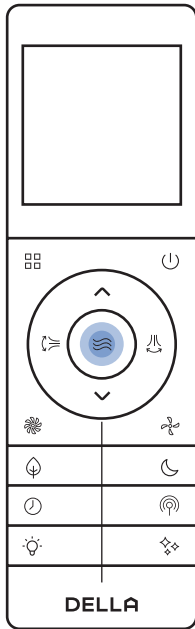

°F / °C

Press and hold  for 5 seconds.

- The temperature unit will switch between °F and °C.

Advance Function
Advance Function

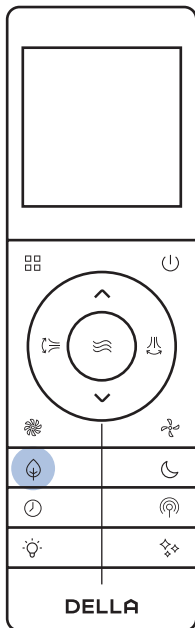

Forced Defrost

To maximize heat efficiency, you can force the outdoor unit to perform a defrost cycle before using heat mode.

In heat mode, press  10 times within 8 seconds.

-  code will display on the indoor unit, and the AC will enter defrost cycle. Once the defrost cycle ends, the AC will automatically resume heat mode operation.

Advance Function

Emergency Buttons

You can use the emergency buttons for limited control of the air conditioner in case the remote control fails or is missing.

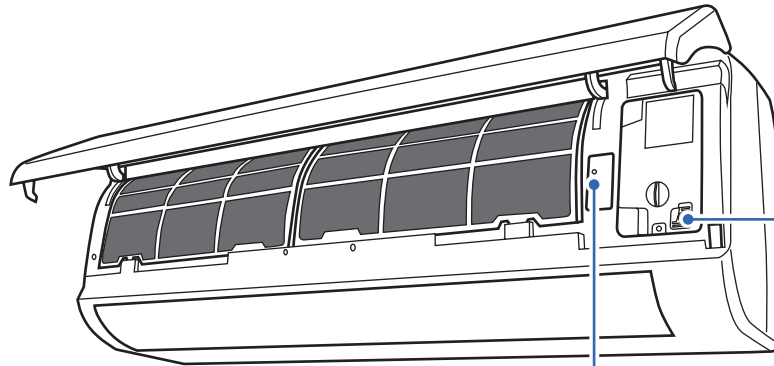

Wi-Fi Reset Button

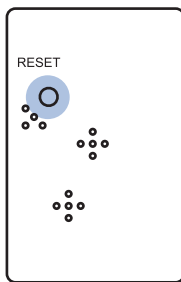

- When the unit is on, press the reset button on the Wi-Fi module to enable Wi-Fi pairing.

Indoor unit ON / OFF Switch

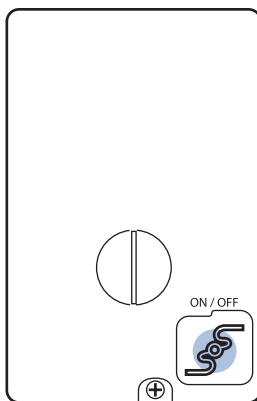

- When the unit is off, press this switch ONCE to start cooling mode
You will hear a beep.
- When the unit is off, press this switch TWICE within 3 seconds to start heating mode.
You will hear beep-beep.
- In operation, press this switch ONCE to turn off the unit.
You will hear multiple beeps.



- Always wear insulation material when pressing the emergency buttons.

We work remotely, too.

The Della app combines smart technology with simple, user-friendly design, providing a seamless experience and endless customization. Automated smart features work behind the scenes to dial in your environment and improve your everyday, so you can focus on other, more interesting things.



DELLA

Living Room



Mode



Fan Speed



Sleep



Airflow

NORMAL
Schedule



Timer



Advance Function

Wi-Fi Set up

Beside the remote control, you can control your Della AC via the Della + app.

1. Search "DELLA+" on Apple app store or Google Play, or scan the QR code below to download the application.
2. Register an account in the app.
3. Follow the in app instructions to add and pair your Della AC to the app and complete the Wi-Fi set up.



Device QR code

Scan this QR code to add device to your Della+ app.



- The Della+ application is free, however, data charges may apply when downloading or using the application.
- Della + can be altered without notice for quality improvement and also be deleted depending on the circumstances of manufacturing firms.
- All trademarks, logo, brand names are the property of their respective companies. Use of these names, brands, and trademarks does not imply endorsement. Della assumes no responsibility with regard to the performance or use of these products.



Check out detailed tutorial on the most updated application on dellahome.com/support

Care and Maintenance



- Before cleaning the unit, you must shut down the machine and cut off the power supply for at least 5 minutes.
- Never flush the air conditioner with water.

Clean the Unit

1. Clean the air conditioner with a soft dry cloth or a dampened cloth with neutral detergent.
2. Remove any possible debris on the vents and air outlet.



Clean the Air Filter

1. Open the front panel.
2. Pull down the air filter.
3. Clean the air filter with soapy water.
4. Air dry the air filter.
5. Put the air filter back to its original position after it is dry.

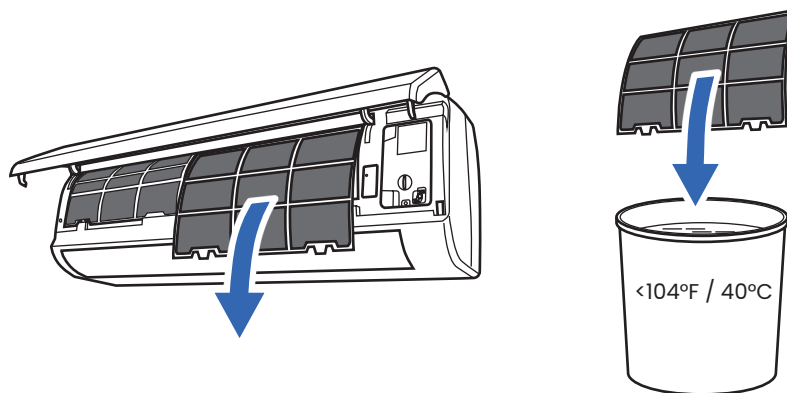

- Do not touch the fins inside the indoor unit with bare hands after removing the filter screen.
- Check and clean the air filter regularly to prevent dust accumulation.
- Clean the air filter frequently if the operating environment is dusty or has bad air quality.

Care and Maintenance

Maintenance Routine

- Clean the air filter screen every 3 months.
- Use the self clean function to clean the indoor unit every 3 months.
- [Page 51](#)
- Call your HVAC technician to check on the refrigerant level every 3 - 4 years.
- Regularly check and remove any obstacles from the outdoor unit.

Planning to Not Operate the Air Conditioner for a Long Period

- Take out the batteries from the remote control and disconnect the power supply of the air conditioner.

Using the Air Conditioner After a Long Idle Period

- Clean the unit and the air filter screen.
- Remove any obstacles at the air inlet and outlet of both the indoor and outdoor unit.
- Make sure drain pipe is unobstructed.
- Install batteries into the remote control and connect the power supply to the air conditioner.

Troubleshooting

Before consulting repair or warranty, please check the following troubleshooting guide.

In the case of an persistent problem, contact a qualified technician for diagnosis and repair.



- When encountering persisting problem, stop operation and turn off the breaker. Continue operation in an abnormal condition may cause electric shock, fire, or damage to the unit.
- Do not attempt to repair or modify the unit by yourself. Incorrect work may result in electric shock, fire or injury.

Problem	Possible Cause / Explanation / Solution
The appliance is non operational	When pressing the power button soon after operation was stopped - Protective delay switch will delay the operation for 3 - 5 minutes if the air conditioner is turned on immediately after it is turned off.
	When switching between operation modes - The internal protection is activated, wait for a few minutes for the AC to resume normal operation.
	The unit is currently has a turn ON timer activated.
	The circuit breaker is tripped. Reset the circuit breaker.
	Faulty electric connection, mismatch outlet voltage, or damaged electronic control board. Contact a qualified technician.
The appliance suddenly stopped during operation	An internal protection tripped after a sudden voltage fluctuation. Check the circuit breaker and reset if necessary.
	The environment temperature is too high or too low.
	The AC automatically activate de-frost process. This is not a malfunction.
	Air filter is too dirty. Clean the air filter.
	Some objects are obstructing air inlet or outlet of the indoor and / or the outdoor unit. Remove the obstructing object.
Strange odor from the air flow	Air filter is too dirty. Clean the air filter.
	The smells of the room, furniture, or cigarettes are absorbed into the unit and then discharged. Remove odorous objects from the room.
Strange Noise	In the case of water flowing noise - The noise may caused by the refrigerant flow, or the internal water flow during cold / dry mode. This is not a malfunction.
	In the case of plastic cracking noise - The noise may caused by the thermal expansion.

Troubleshooting

Problem	Possible Cause / Explanation / Solution
Mist comes out from the air outlet	This occurs when the air in the room becomes cold in cool or dry mode. This does not indicate a problem.
No cool air in cold mode	When switching between operation modes - The internal protection is activated, wait for a few minutes for the AC to resume normal operation.
	Check and make sure the temperature setting is below the environment temperature.
No warm air in heat mode	When switching between operation modes - The internal protection is activated, wait for a few minutes for the AC to resume normal operation.
	Check and make sure the temperature setting is below the environment temperature.
	The AC automatically activate de-frost process. This is not a malfunction. Wait 2 - 10 minutes for the AC to complete defrosting.
	Frost built up on the outdoor unit. If the AC does not automatically activate de-frost process, force defrost process following instruction on page 52.
Insufficient air flow, either cold or hot	Some objects are obstructing air inlet or outlet of the indoor and / or the outdoor unit. Remove the obstructing object.
	Other heat source of heat in the room. Remove the heat source.
	The fan speed is set to minimum. Try to set at a higher fan speed.
The unit does not respond to the remote control commands	Remote Control is too far away from the indoor unit.
	There is an obstruction between the remote control and the indoor unit.
	The battery power has run out in the remote control. Replace the battery.
	Child lock function is activated. Deactivate child lock on the remote control.
The display on the indoor unit is not lit	The display is set to off on the remote control. Use the remote control to turn it on.
	Power failure. Check the power supply / circuit breaker.
Water dripping from the outdoor unit	The indoor unit internal is too dirty and clogged the drainage port. Contact qualified technician for cleaning.
	Condensation formed on the uninsulated drainage hose / refrigerant pipe in the line set. Contact qualified technician to properly insulate the water hose / refrigerant pipes.
	Improper drainage hose installation.

Having Problems?
Having Problems?

Troubleshooting



Switch off the air conditioner immediately and cut off the power supply in the event of:

- Strange, loud noises during operation.
- Faulty electronic control board.
- Faulty fuses or switches.
- Spraying water or objects inside the appliance.
- Frequent circuit breaker tripped during operation.
- Abnormally hot or damaged power cord or plug.
- Very strong smells discharging from the appliance.

Error Code

Error Code	Description
E1	Indoor room temperature sensor fault
E2	Indoor pipe temperature sensor fault
E3	Outdoor pipe temperature sensor fault
E4	Refrigerant system leakage or fault
E6	Malfunction of indoor fan motor
E7	Outdoor ambient temperature sensor fault
E0	Indoor and outdoor communication fault
E8	Outdoor discharge temperature sensor fault
E9	Outdoor IPM module fault
EA	Outdoor current detect fault
EE	Outdoor PCB EEPROM fault
EF	Outdoor fan motor fault
EH	Outdoor suction temperature sensor fault

Having Problems?
Having Problems?

Troubleshooting

Error codes shown on the air conditioner display panel only indicates communication problems between parts. For technicians attempt to identify the exact problematic parts or componants, visit our page on dellahome.com/pages/Versa-troubleshooting for detailed model specific diagnostic handbook.



dellahome.com/pages/Versa-troubleshooting

Disposal Guideline

This appliance contains refrigerant and other potentially hazardous materials. When disposing of the appliance, follow all federal, state, and local regulations. DO NOT dispose of this product as normal household waste or unsorted municipal waste.

When disposing of this appliance, you have the following options:

- Dispose of the appliance at a designated municipal electronic waste collection facility.
- When buying a new appliance, the retailer will take the old appliance.
- The manufacturer may take back the old appliance.
- Sell the appliance to a certified scrap metal dealer.

Warranty



Scan the QR code or visit our page on dellahome.com/pages/warranty to sign up for warranty coverage on your new DELLA appliance.



dellahome.com/pages/warranty

WARRANTY COVERAGE

DELLA distributor (hereinafter “Company”) warrants this product against failure due to defect in materials or workmanship under normal use and maintenance as follows: All warranty periods begin on the date of purchase. If a part fails due to defect during the applicable warranty period, Company will provide a new or remanufactured part, at Company’s option, to replace the failed defective part at no charge for the part. This limited warranty is subject to all provisions, conditions, limitations and exclusions listed below.

STANDARD WARRANTY

- The standard warranty period is one (1) year for the entire unit and all parts, with no registration required.

EXTENDED WARRANTY

- The extended warranty period for a complete new Della system (outdoor and indoor unit) is lifetime on all parts and compressor.
- In order to qualify for the free extended warranty the unit must be:
 1. Registered within one hundred (100) days of purchase.
 2. Must be with the original owner.
 3. In the same address of residence that you entered with your registration.

WARRANTY PARTS REPLACEMENT

- Some parts may need to be returned to Della. The limited lifetime warranty covers only parts that need to be replaced
For more information, please contact Della.



Warranty

LIMITED WARRANTY STATEMENT

LIMITATIONS OF WARRANTIES: ALL IMPLIED WARRANTIES AND/OR CONDITIONS (INCLUDING IMPLIED WARRANTIES OR CONDITIONS OF MERCHANTABILITY AND FITNESS FOR A PARTICULAR USE OR PURPOSE ARE LIMITED TO THE DURATION OF THIS LIMITED WARRANTY. SOME STATES DO NOT ALLOW LIMITATION ON HOW LONG AN IMPLIED WARRANTY OR CONDITION LASTS, SO THE ABOVE MAY NOT APPLY TO YOU THE EXPRESS WARRANTIES MADE IN THIS WARRANTY ARE EXCLUSIVE AND MAY NOT BE ALTERED ENLARGED, OR CHANGED BY ANY DISTRIBUTOR, DEALER, OR OTHER PERSON, WHATSOEVER.

THIS LIMITED WARRANTY DOES NOT COVER:

1. Labor or other costs incurred for diagnosing, repairing, removing, installing, shipping, servicing or handling of either defective parts, or replacement parts, or new units.
2. Product cleaning required prior to warranty service and repair.
3. Normal maintenance as outlined in the installation and servicing instructions or Owner's Manual, including filter cleaning and/or replacement and lubrication.
4. Failure due to faulty installation or repairs, damage, misapplication, abuse, improper servicing, lack of or in-sufficient maintenance, unauthorized alteration or improper operation.
5. Failure to start due to voltage conditions, improper wiring, blown fuses, open circuit breakers, or damages due to the inadequacy or interruption of electrical service.
6. Failure or damage due to floods, winds, fires, lightning, accidents, corrosive environments (rust or residue etc.) or other conditions beyond the control of the Company.
7. Damages due to chemicals (volatile organic compounds, sulfur, acids, etc.) or particulates.
8. Failure or damage of coils, piping or other parts due to corrosion, when installed in corrosive environments or within one (1) mile of seacoast.
9. Parts not supplied or designated by Company, or damages resulting from their use.
10. Products installed outside the 48 contiguous United States, except the District of Columbia and Hawaii, and Canada.
11. Electricity or fuel costs or increases in electricity or fuel costs from any reason whatsoever, including additional or unusual use of supplemental electric heat.
12. Any cost to replace, refill or dispose of refrigerant, including the cost of refrigerant.
13. Shipping damage or damage as a result of transporting the unit.
14. Accessories such as condensate pumps, line sets and so forth are not covered.
15. Any special, indirect or consequential property or commercial damage of any nature whatsoever. Some states do not allow the exclusion of incidental or consequential damages, so the above limitation may not apply to you.
16. Consumable components, such as air filters, are not covered under parts warranty.

This warranty gives you specific legal rights, and you may also have other rights which vary from state to state. In jurisdictions where warranty benefits conditioned on registration are prohibited by law, registration is not required, and the STANDARD warranty period shown above will apply.

Compliance Information

Radio Frequency Interference



Model: 048-TL series

ID: 2ANDL-TYWE1S

FCC Caution

This device complies with part 15 of the FCC Rules. Operation is subject to the following two conditions:

(1) This device may not cause harmful interference, and (2) this device must accept any interference received, including interference that may cause undesired operation. Any changes or modifications not expressly approved by the party responsible for compliance could void the user's authority to operate the equipment.

NOTE: This equipment has been tested and found to comply with the limits for a Class B digital device, pursuant to Part 15 of the FCC Rules.

These limits are designed to provide reasonable protection against harmful interference in a residential installation. This equipment generates, uses and can radiate radio frequency energy and if not installed and used in accordance with the instructions, may cause harmful interference to radio communications. However, there is no guarantee that interference will not occur in a particular installation. If this equipment does cause harmful interference to radio or television reception, which can be determined by turning the equipment off and on, the user is encouraged to try to correct the interference by one or more of the following measures:

- Reorient or relocate the receiving antenna.
- Increase the separation between the equipment and receiver.
- Connect the equipment into an outlet on a circuit different from that to which the receiver is connected.
- Consult the dealer or an experienced radio / TV technician for help.

Memo





 www.dellahome.com

 support@dellahome.com

 800-863-4143

 6:00 a.m. – 4:00 p.m. PST Monday – Friday

© Della All rights reserved.

The design and specifications are subject to change without prior notice for product improvement. Any updates to the manual will be uploaded to the della website.
